

Enclosed Conductor Rail

BoxLine Program 0842

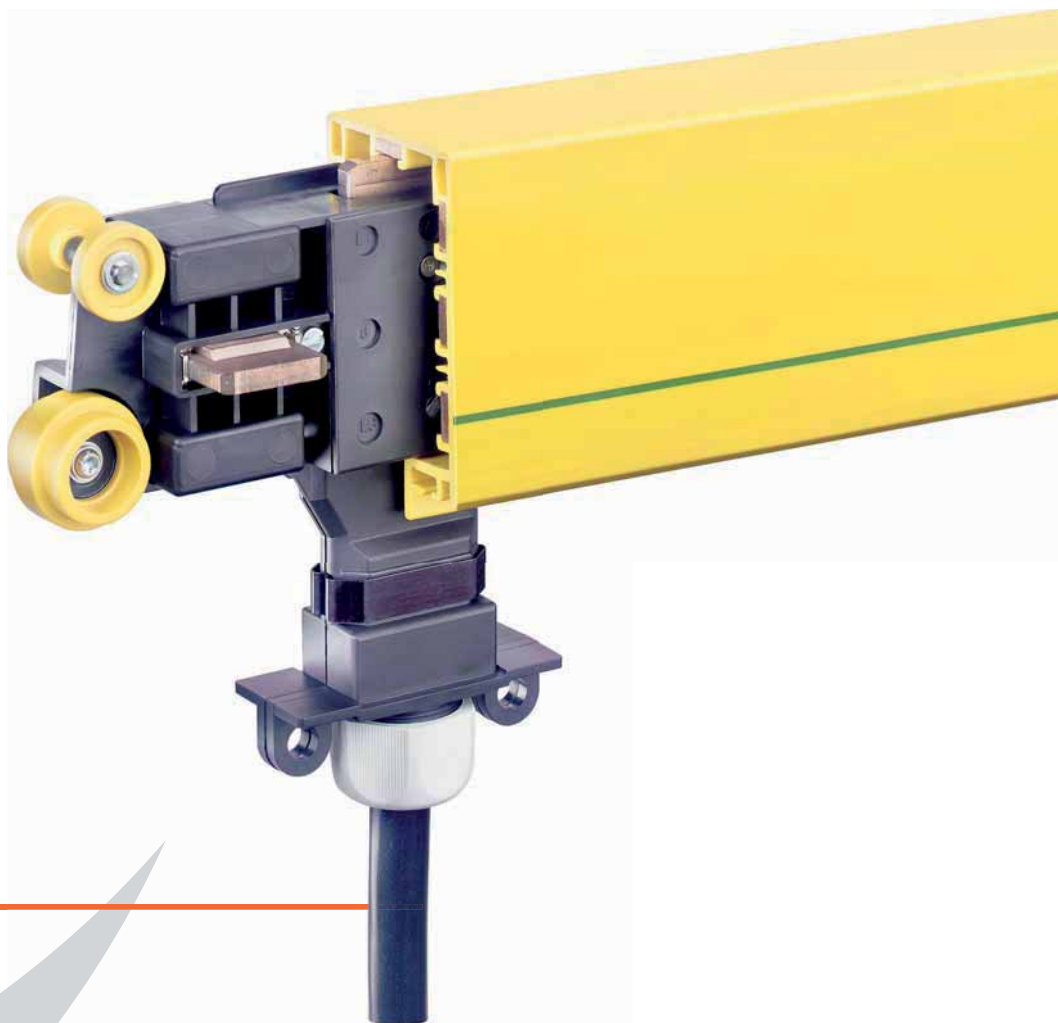

CONDUCTIX
wampfler

Ⓞ DELACHAUX GROUP

Contents

Description	
Enclosed Conductor Rails Program 0842 BoxLine	2
The Advantages	2
The System Components	2
Connection Alternatives	3
Technical Data Enclosed Conductor Rails Program 0842 BoxLine	4
Enclosed Conductor Rail System PL (Plug-in Type, 4 Poles)	5
Order Example for a Simple Complete System	5
Conductor Rails and Joint Covers	
System CS (Continuous Strip) and System PL (Plug-in Type)	6
System JT (Joint Clamping) and System AN (Angle Clamping)	7
Rail Curves	
Horizontal Curves	8
Vertical Curves	8
Order Number Code for Curve, System AN (Angle Clamping)	8
Hanger Clamps and Anchor Clamps	
Hanger Clamp	10
Anchor Clamp	10
Hanger Clamp for Higher Temperature Range	10
End Feeds and End Caps	
End Feed up to 60A for CS (Continuous Strip), PL (Plug-in Type) and AN (Angle Clamping)	11
End Feed up to 100A for CS (Continuous Strip) and up to 140A for JT (Joint Clamping)	11
End Cap	11
In-line Feeds	
In-line Feeds with Single Core Cable Entry up to 60A and In-line Feeds Joint Covers AN (Angle Clamping)	12
In-line Feeds with Terminal Box up to 140A	13
Expansion Joints	
General Expansion Joint Data	14
Example: Setting the Expansion Joint Depending on the Temperature	14
Expansion Joints (with 100 mm Expansion) for System CS (Continuous Strip)	15
Expansion Joints (with 100 mm Expansion) for the Systems PL, JT and AN	15
Pick-up Guides	
Pick-up Guides for Transfer Points	16
Conversion Retrofit Kits to Add a Power Feed Point to Pick-up Guides/Transfer Points	16
Pick-up Guides for Entrance Points	17
Pick-up Working Range	17
Collectors and Accessories	
Collector with Connection Cable	18
Double Collector	18
Collector up to 7 Poles; with Single Cores in a Flexible Conduit	19
Towing Arm	19
Wear Parts and Accessories	
Sealing Lip	21
Reinforcing Bracket for Plastic Housing and Storm Safety Device	21
Conversion Retrofit Kits to Add a Power Feed Point to Pick-up Guides/Transfer Points	21
Half Shells	21
Collectors Shoes for Collectors	21
Assembly Tools	
Strip Insertion Trolley for System CS (Continuous Strip)	22
De-coil Unit for Simplified Strip Insertion - Optional (System CS)	22
Bending Device for Chamfering the Copper Strip for System AN (Angle Clamping)	22
Positioning Block for System AN (Angle Clamping) and Insertion Tool for Sealing Lip	22
Support Arm (Optional), Girder Clip (Optional) and Weld-on Bracket for Support Arm (Optional)	23
Program Overview	
Conductor Rails	24
General Hints	24

Description

Enclosed Conductor Rails Program 0842 BoxLine

The conductor rail program 0842 completes the Conductix-Wampfler product line of conductor rails by an enclosed conductor rail system for indoor and outdoor use.

The established, universally applicable system is used on crane systems, transfer carriages, tasksaver systems, electric hoisting equipment, theater applications and a variety of other mobile consumers for indoor and outdoor use, ideally suited for straight tracks.

The Advantages

The system 0842 is mainly characterized by the following features:

- Enclosed profile with captured collector
- Collector cable exits the system from the lower slot
- High variability by 4 different types of system connection
- Fast and safe assembly by adjustable and rotating snap-in hanger clamps and other innovative details
- Supplied in easy to handle 4 m sections
- High protection against direct contact and compliance with international standards
- Broad selection of accessories

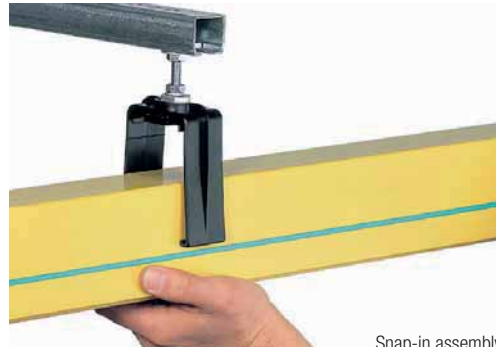

Snap-in assembly

The System Components

Conductor Rails

The conductive strips made of copper or datametal are fastened in high-quality plastic insulating profiles and are available with 4, 5 and 7 poles with a nominal current of 35 to 140A.

Standard profile lengths of 4000 mm allow a simple application and fast progress in the assembly.

Shorter lengths are available on inquiry.

Devices for optional sealing lips, a guiding notch for the defined introduction of the collector trolley and the integrated PE-identification complement the profile.

Hanger clamp

- Plug-in type: System PL to plug-in up to 60A
- Angle clamping: system AN screwable up to 60A
- Joint clamping: system JT screwable up to 140A

As an alternative to the above solutions, the continuous strip version: system CS is available to eliminate connection points (available up to 100Amps). A combination of the systems CS and AN allows an easy changeover between the segments, as on a combination with curves.



Suspension

Swivelling and adjustable snap-in hanger clamps allow for the fast, safe and optimized one-man assembly of the rail segments.

Power feed points are available as end feed and center feed. Moreover it is possible to use transfer segments as feedings with the application of a conversion kit.

Expansion joint

Changes in ambient temperature coupled with normal electrical heating of the conductors causes linear expansion. Expansion joints are used for the absorption of this expansion. The number of required expansion joints is determined by difference in temperature and the system or segment length. Additional power feeding or additional power feeds are not required when using expansion joints as the continuity of the system is not interrupted.

Entrance and transfer segments

For isolation or disconnection points within the conductor rail system (i.e. for the isolation of a section of a line), pick-up guides are used for the entry and exit of the collector.

Collector trolley

The roller-guide collector trolleys are available as 4, 5 and 7 pole types. Copper graphite carbon shoes are used for energy and control voltages over 35V. For the data transmission and low voltage below 35V we recommend silver graphite carbons in connection with a datametal conductor. Double collectors are used to improve the quality of the contact and for transfers (for further information refer to the collector section).

Towing arm

Towing arms are designed as the attachment point between the moving machine and the collector. They are available in „fork“ or chain versions, both of which are designed for straight, uninterrupted tracks or a special spring-loaded design is available for systems with pick-up guides/isolation sections.

Description

Connection Alternatives

High flexibility by various techniques for joining parts for each required system.

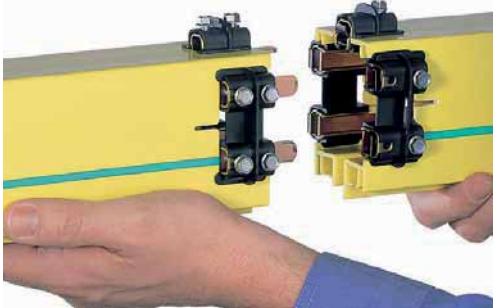

System PL (plug-in type)

Plug-in type (system PL)

Characteristics:

- Simple plug-in
- Ideal for short systems
- From 35A up to 60A (100% ED)

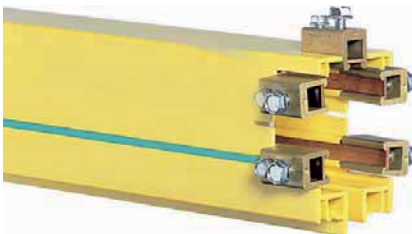

System JT (joint clamping)

Joint clamping type (system JT)

Characteristics:

- Fast joining
- Designed for large cross sections
- From 100A up to 140A (100% ED)

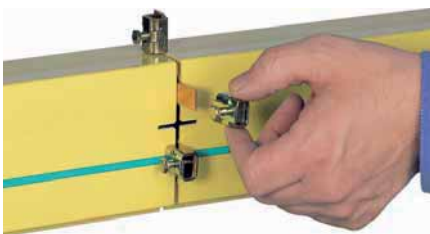

System AN (angle clamping)

Angle clamping type (system AN)

Characteristics:

- Quick flexible solution
- Can be combined with continuous strip version
- From 35A up to 60A (100% ED)

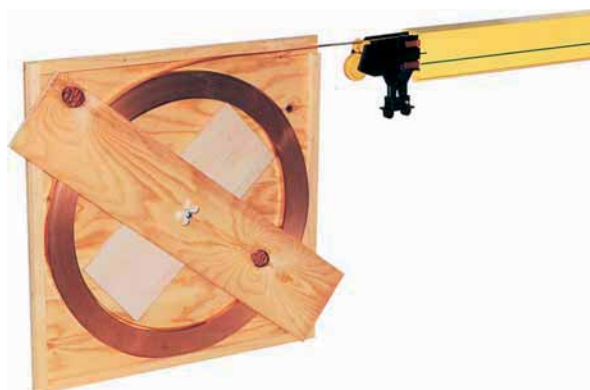

System CS (continuous strip)

Continuous strip type (system CS)

Characteristics

- For conductor guide free of disconnecting points
- Fast and simple on-site assembly
- 35A, 60A up to 100A (100% ED)

For further installation details see installation instructions for program 0842

Description

Technical Data Enclosed Conductor Rails Program 0842 BoxLine

Type	084210- ...				084211- ...		084213- ...		084212- ...	
Rail System Configuration	Continuous Strip (CS)				Plug-in Type (PL)		Bolted Type			
							Angle Clamping (AN)		Joint Clamping (JT)	
Nom. Current at 100% ED and 35°C [A]	10	35	60	100	35	60	35	60	100	140 ¹⁾
Cross Section Area of Conductor [mm ²]	10	10	16	25	10	16	10	16	25	40
Resistance [Ω/m]	0.0808	0.0019	0.0011	0.0006	0.0019	0.0011	0.0019	0.0011	0.0007	0.0004
Impedance at 60 Hz [Ω/m]	0.0889	0.0021	0.0012	0.0008	0.0021	0.0012	0.0021	0.0012	0.0008	0.0004
Material	Datametal				Copper					

1) 160 A at 80% duty cycle

Basic Variants / Lengths of Profile	4, 5 and 7 poles / 4 m (sub-lengths: 1 m, 2 m, 3 m)					
Nominal Voltage	35 ... 690 V					
Installation Position	slot downwards; as shown below					
Support Spacing	max. 2000 mm (500 mm curves)					
External Dimensions	56 x 90 mm					
Travel Speed	up to 150 m/min straight track (< 85 m/min on transfers)					
Standard Current Strip Arrangement	<p>4 poles: L1, L2, L3, PE</p> <p>5 poles: L1, L2, L3, 4, PE</p> <p>7 poles²⁾: L1, L2, L3, ④, ⑤, ⑥, PE</p>					
Special Current Strip Arrangement	<p>example 6 poles: L1, L2, L3, ⑤, ⑥, PE</p>					
		Nominal Current [A]	35	60	100	140
Conductor Cross Section Area	L1, L2, L3, 4	[mm²]	10	16	25	40
	④, ⑤, ⑥	[mm²]	10			
	PE	[mm²]	10	16	25	
Permissible Ambient Temperature	-30 to +55°C					
Difference in Temperature	Δθ ≤ 50 K (Please contact us for higher temperature variations)					
Standard	EN 60204					
Dielectric Strength	22.4 kV/mm					
Surface Resistance	600 ≤ CTI					
Combustibility of Insulation Cover	regarding UL 94 V - 0					
Protection Type	IP 23 (with sealing lips IP 24)					
Wind speed	max. 60 km/h, for higher wind speed in exposed position >3 m add. storm clamber recommended (see page 21)					
Chemical Resistance of the Profile at an Ambient Temperature of +45°C	<p>benzine resistant sodium hydroxide 25% resistant</p> <p>mineral oil resistant hydrochloric acid resistant</p> <p>grease resistant sulphuric acid up to 50% resistant</p> <p>The materials of the conductor rail system are weather resistant and have a high resistance against certain chemicals. For special applications please contact us. Please be careful with solvents and contact sprays.</p>					

2) In case of system extension please check the pole disposition. Systems built before 2000 have a different pole disposition (see also MV0842-0020DEF or the respective documentation of the system).

Description

Enclosed Conductor Rail System PL (Plug-in Type, 4 Poles)

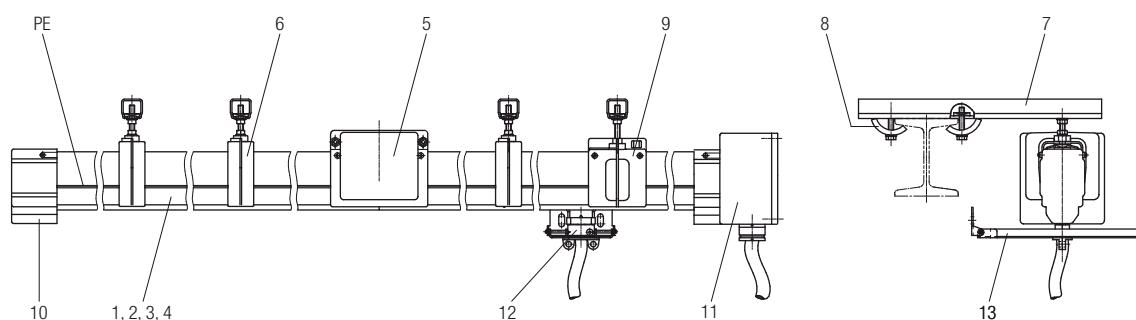

For straight systems (L1, L2, L3, PE) of limited length at low/medium load it is recommended to use 4 pole- "plug-in type" with standard components.

Order Example for a Simple Complete System

Item	Pc.	Parts for 35A Order No.	Designation	Parts for 60A Order No.
1	.. ¹⁾	084211-34x4x12	Conductor rail, 4 m long	084211-54x4x12
2	.. ¹⁾	084211-33x4x12	Conductor rail, 3 m long	084211-53x4x12
3	.. ¹⁾	084211-32x4x12	Conductor rail, 2 m long	084211-52x4x12
4	.. ¹⁾	084211-31x4x12	Conductor rail, 1 m long	084211-51x4x12
5	.. ¹⁾	084222-0	Joint cover	084222-0
6	.. ¹⁾	084243-11	Hanger clamp with steel square nut	084243-11
7	.. ¹⁾	020185-0500	Support arm, 500 mm long	020185-0500
8	.. ¹⁾	020181-08	Girder clip with support distance 6-25 mm	020181-08
9	1	084233-11	Anchor clamp with steel square nut	084233-11
10	1	084271	End cap	084271
11	1	084251-051	End feed	084251-052
12	1	084201-4x11 ²⁾	Collector with 1 m connection cable	084201-4x21 ³⁾
13	1	084291-2	Fork-type towing arm	084291-2

1) Variable in accordance with the system length

2) Nominal current at 60% duty cycle: 25 A

3) Nominal current at 60% duty cycle: 40 A

Conductor Rails and Joint Covers

System CS (Continuous Strip)

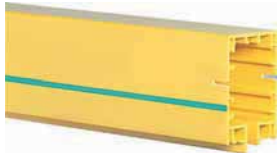

Plastic casing

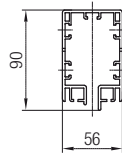

Technical details

- Current strips are delivered in cartons ready for de-coiling
- It is recommended to use datametal for energy and data transmission in corrosive environments and/or at system voltage approx. $\leq 35V$
- Standard current strip arrangement see page 4



Joint cover

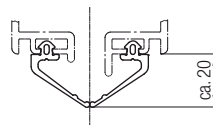
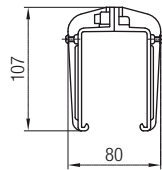

Optional sealing lip see page 21

	Poles	Nom. Current [A]	Strip Material	Max. Length [m]	Weight	Order No.
Plastic Casing	5	-	-	4	5.20 kg	084210-04x5x13
	7	-	-	4	5.40 kg	084210-04x7x12
Current Strip	-	35	Copper	300	0.08 kg/m	084214-3xL ¹⁾
	-	60		200	0.15 kg/m	084214-5xL ¹⁾
	-	100		100	0.23 kg/m	084214-6xL ¹⁾
	-	10	Datametal	300	0.07 kg/m	084214-8xL ¹⁾
Joint Cover	-	-	-	-	0.12 kg	084221-0

1) L = requested strip length per pole [m]

System PL (Plug-in Type)

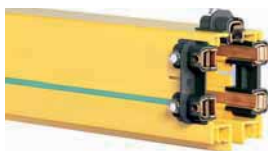

Conductor rail

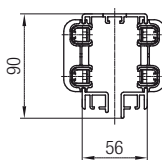

Technical details

Standard current strip arrangement see page 4



Joint cover

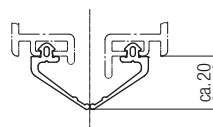
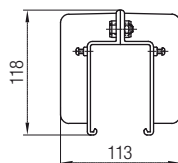

Optional sealing lip see page 21

	Poles	Nom. Current [A]	Strip Material	Max. Length [m]	Weight	Order No.
Conductor Rail	4	35	Copper	4	7.22	084211-34x4x12
	5				7.63	084211-34x5x13
	7				8.79	084211-34x7x15
	4	60	Copper		8.21	084211-54x4x12
	5				8.87	084211-54x5x13
	7				9.80	084211-54x7x15
Joint Cover	-	-	-	-	0.24	084222-0

Conductor Rails and Joint Covers

System JT (Joint Clamping)

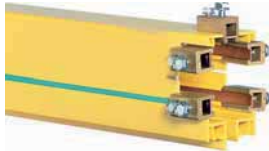

Plastic casing

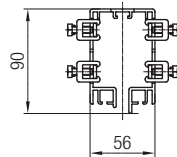

Technical details

Standard current strip arrangement see page 4



Joint cover

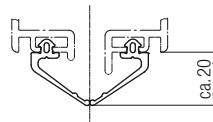
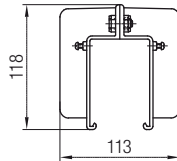

Optional sealing lip see page 21

	Poles	Nom. Current [A]	Strip Material	Max. Length [m]	Weight [kg]	Order No.
Conductor rail	4	100	Copper	4	9.40	084212-64x4x12
	5				10.40	084212-64x5x13
	7				11.20	084212-64x7x15
	4	140	Copper		11.15	084212-74x4x12
	5				12.64	084212-74x5x13
	7				12.87	084212-74x7x15
Joint cover	-	-	-	-	0.24	084222-0

System AN (Angle Clamping)

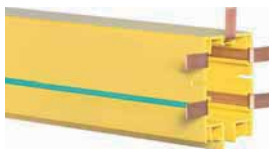

Conductor rail

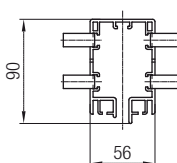

Technical details

- Standard current strip arrangement see page 4
- Edging tool for the conductor strip see page 22



Joint cover

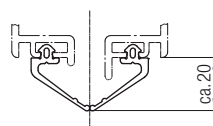
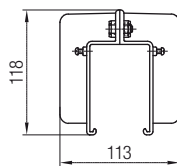

Optional sealing lip see page 21

	Poles	Nom. Current [A]	Strip Material	Max. Length [m]	Weight [kg]	Order No.
Conductor Rail	4	35	Copper	4	6.98	084213-34x4x12
	5				7.34	084213-34x5x13
	7				8.35	084213-34x7x15
	4	60	Copper		8.03	084213-54x4x12
	5				8.60	084213-54x5x13
	7				9.36	084213-54x7x15
Joint Cover	4	-	-	-	0.32	084224-4 ¹⁾
	5	-	-	-	0.34	084224-5 ¹⁾
	7	-	-	-	0.38	084224-7 ¹⁾

1) incl. covering terminals L2 and ©

Rail Curves

General Rail Curve Data

- There is a distinction between horizontal-/vertical curves and inner-/outer curves.
- The minimum radius depends on the collector type.
- The hanger clamp distance at curves shall not exceed 500 mm.
- The overall curve length should not exceed 2360 mm.
- AN (angle clamping) is the preferred joint system for curves. Appropriate conductor rail connection adapters are available for joining with other systems (e.g. system PL „plug-in type“).
- Curves act as anchor points within the system. Therefore, if expansion is not accommodated by the steel structure (i.e. slotted holes at the attachment point), the use of expansion joints is recommended (see pages 14/15).
- Adaption segments (200 mm long) for system PL available

Horizontal Curves

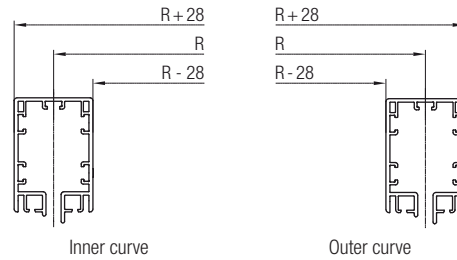
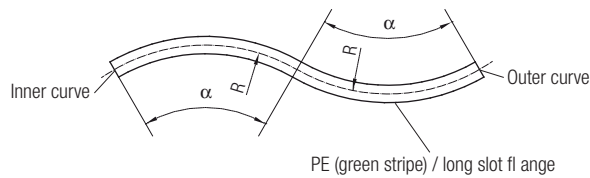

Radius R [mm]	Angle α
$800 \leq R < 2750$ ¹⁾	On request
$2750 \leq R < 3000$	0° - 45°
$3000 \leq R < 4500$	0° - 30°
$4500 \leq R < 6000$	0° - 22.5°
$6000 \leq R$	On request

For radii greater than/equal to 27000 mm, bending is not required.

1) Special collector required for this configuration

Vertical Curves

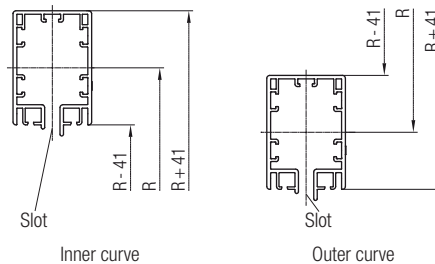
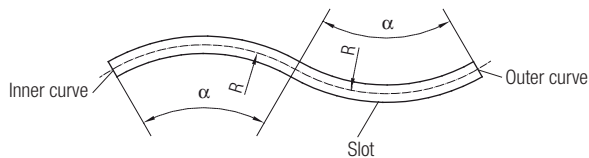
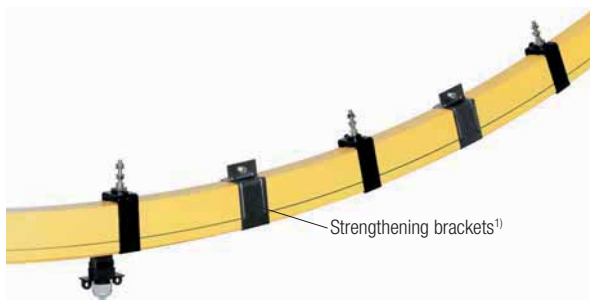

Radius R [mm]	Angle α
$3000 \leq R < 5000$ ²⁾	On request
$5000 \leq R < 6000$	0° - 22.5°
$6000 \leq R$	On request

1) See page 21

2) Special collector required for this configuration

Order Number Code for Curve, System AN (Angle Clamping)

084213 X B X 2750 - 030 X x X x 12

H = Horizontal / V = Vertical
 I = Inner- / A = Outer curve
 Radius (e.g. 2750 mm)

Poles: 4, 5, 7
 Current: 3 = 35A; 5 = 60A
 Angle α (e.g. 30°)

Adapters for other systems on request!

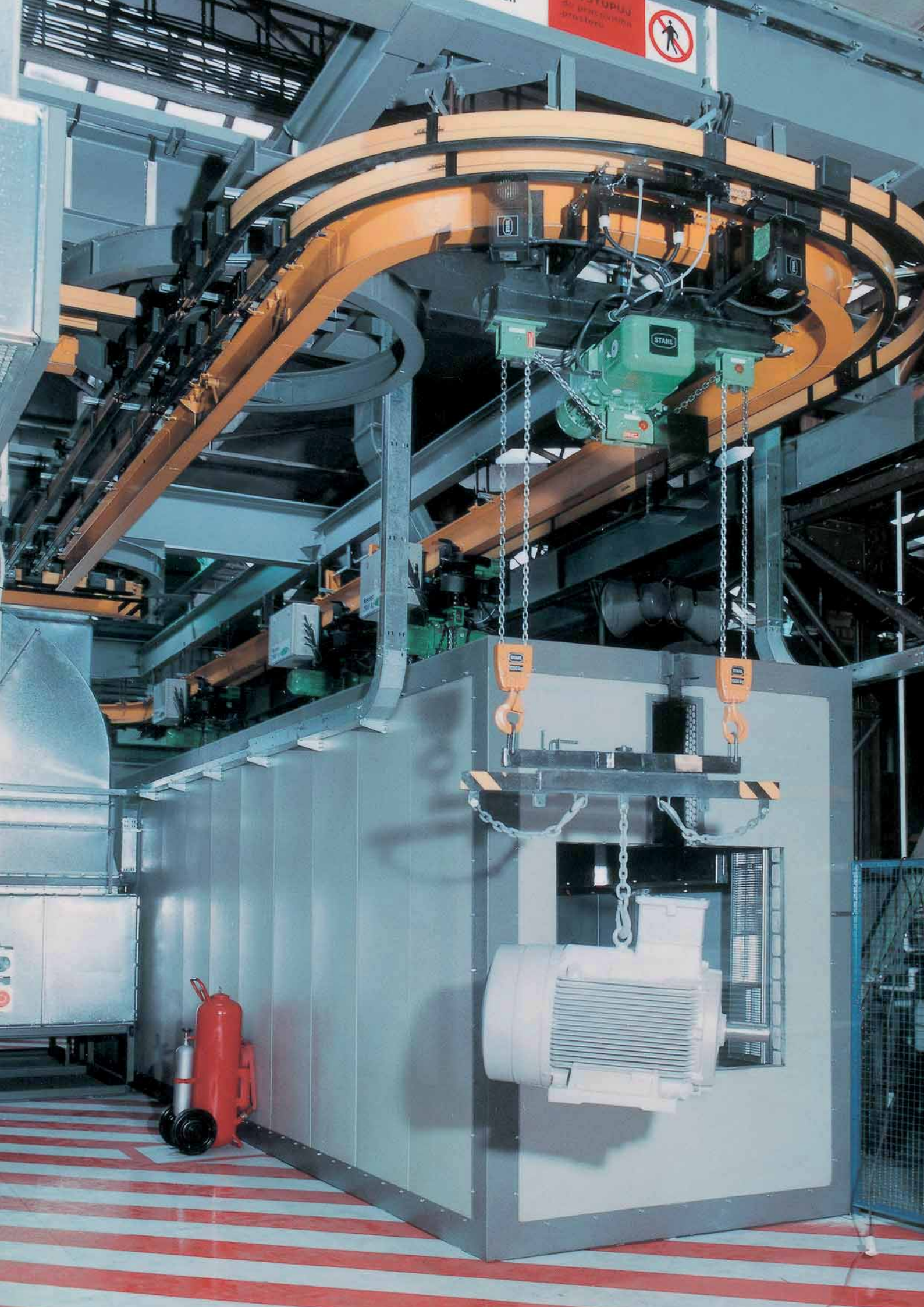

Hanger Clamps and Anchor Clamps

Hanger Clamp



Type with normal steel hex nut

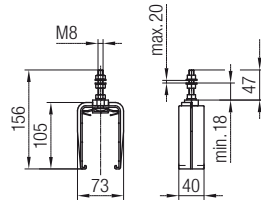

Order No. 084241-11

Technical details

- Material: plastic; steel
- Snap-in type; swivelling
- Support distance ≤ 2000 mm
- Weight: 0.11 kg



Type with steel square nut

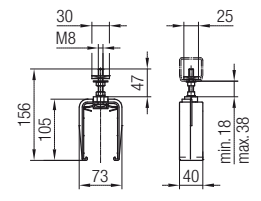

Order No. 084243-11

Technical details

- Material: plastic; steel
- Snap-in type; swivelling
- For support arm assembly
- Support distance ≤ 2000 mm
- Weight: 0.14 kg

Anchor Clamp



Type with normal steel hex nut

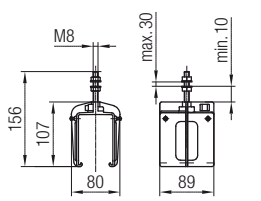

Order No. 084231-11

Technical details

- Material: plastic; steel
- Weight: 0.16 kg



Type with steel square nut

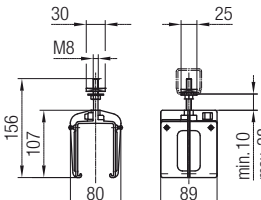

Order No. 084233-11

Technical details

- Material: plastic; steel
- For support arm assembly
- Weight: 0.18 kg

Hanger Clamp for Higher Temperature Range

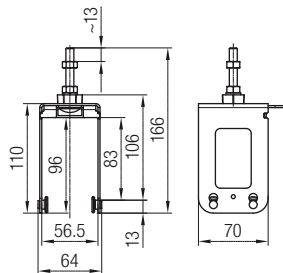

Order No. 084245-22

Technical details

- Material: galvanised steel
- Weight: 0.4 kg
- Incl. universal hex and square nuts set for flexible installation

Notes

- Hanger clamp with integrated rollers
- Recommended for application with higher temperature range (temperature range $> 40K$)

End Feeds and End Caps

End Feed up to 60A for CS (Continuous Strip), PL (Plug-in Type) and AN (Angle Clamping)

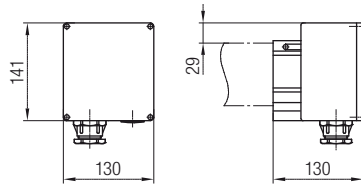

Technical details

- Housing material: plastic
- Cable lugs included
- For joint systems PL and AN few modifications are required on-site.
- Further details see installation instructions program 0842

Order No.	Poles up to	Gland	Nom. Current [A]	Cable Lug [mm ²]	Weight [kg]
084251-051	5	Pg 21	35	10	0.71
084251-052		Pg 29	60	16	0.71
084251-071	7	Pg 21	35	10	0.84
084251-076		Pg 29 + Pg 11	60	16	0.85

End Feed up to 100A for CS (Continuous Strip) and up to 140A for JT (Joint Clamping)

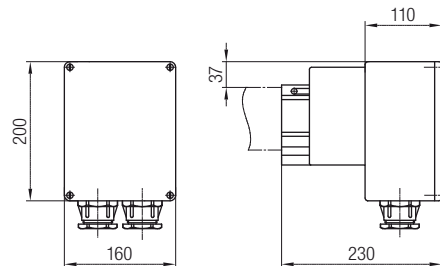

Technical details

- Housing material: plastic
- Cable lugs included

Order No.	Poles up to	Gland	Nom. Current [A]	Cable Lug [mm ²]	Weight [kg]
084251-053x60	5	Pg 36	100	25	1.30
084251-053x70		Pg 36	140	35	1.30
084251-077x60	7	1 x Pg 36; 1 x Pg 11	100	25 ¹⁾	1.35
084251-077x70		1 x Pg 36; 1 x Pg 11	140	35 ²⁾	1.35

1) 4 cable lugs 25 mm² + 3 cable lugs 2.5 mm²

2) 4 cable lugs 35 mm² + 3 cable lugs 2.5 mm²

End Cap



Standard type

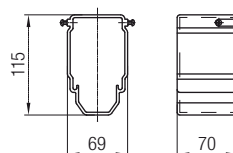

Order No. 084231-11

Technical details

- Material: plastic
- Weight: 0.31 kg



Type for connection of bus terminating resistors

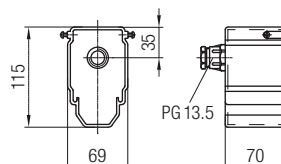

Order No. 084272

Technical details

- Material: plastic
- Weight: 0.14 kg

In-line Feeds

In-line Feeds with Single Core Cable Entry up to 60A

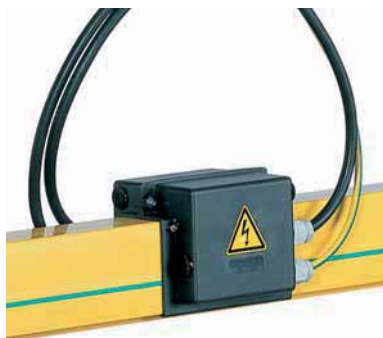

Technical details

- Single core
- 2 separate feedings for 7 pole systems

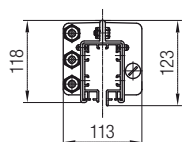

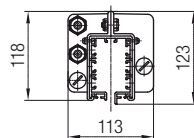
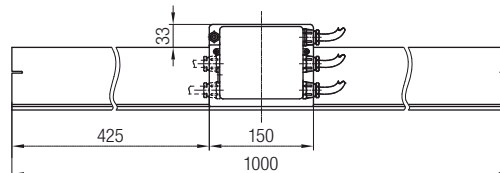

4/5 poles

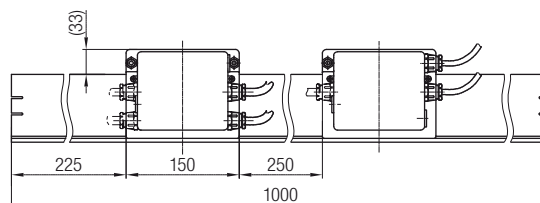

7 poles



In-line Feeds for System	Poles	Nom. Current [A]	Feeding			Control Feeding			Weight [kg]	Order No.
			[Pc.]	L [m]	[mm ²]	[Pc.]	L [m]	[mm ²]		
 CS (continuous strip)	4	up to 60	4	2	10	-	-	-	3.80	084252-040x52
	5		5	2	10	-	-	-	4.30	084252-050x53
	7		4	2	10	3	2	2.5	4.40	084252-070x55
 PL (plug-in type)	4	35	4	2	10	-	-	-	4.20	084252-240x32
	5		5	2	10	-	-	-	4.90	084252-250x33
	7		4	2	10	3	2	2.5	5.45	084252-270x35
	4	60	4	2	10	-	-	-	4.40	084252-240x52
	5		5	2	10	-	-	-	5.20	084252-250x53
	7		4	2	10	3	2	2.5	5.67	084252-270x55
 AN (angle clamping)	7	35	4	2	10	3	2	2.5	5.00	084252-170x35
		60	4	2	10	3	2	2.5	5.40	084252-170x55

L = connection cable length

In-line Feeds Joint Covers AN (Angle Clamping)

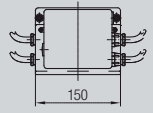
In-line Feeds for System AN	Poles	Nom. Current [A]	Feeding			Control Feeding			Weight [kg]	Order No.
			[Pc.]	L [m]	[mm ²]	[Pc.]	L [m]	[mm ²]		
 AN (angle clamping)	4	up to 60	4	2	10	-	-	-	1.90	084252-140x50
	5		5	2	10	-	-	-	2.50	084252-150x50
For installation instead of joint cover.										

L = connection cable length

In-line Feeds

In-line Feeds with Terminal Box up to 140A

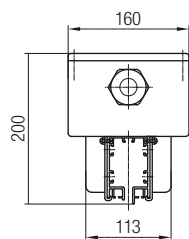

4/5 poles

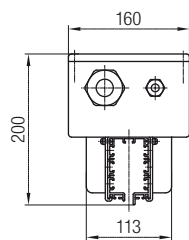
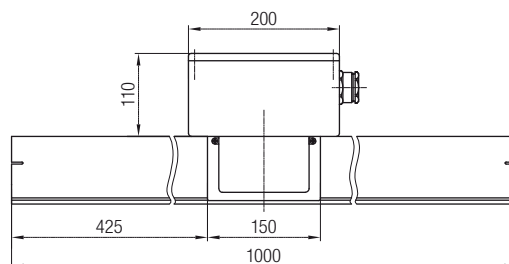



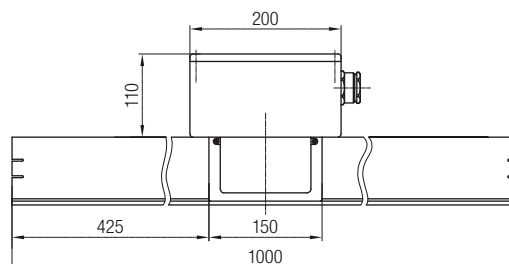

7 poles



Technical details



- Terminal box
- 2 separate cable fittings for 7 pole systems

In-line Feeds for System	Poles	Nom. Current [A]	Pg	Feeding Cable Lugs		Control Feeding Cable Lugs			Weight [kg]	Order No.
				Pc.	[mm ²]	Pg	Pc.	[mm ²]		
 CS (continuous strip)	4	up to 60	29	4	16	-	-	-	2.50	084252-042x52
	5			5		-	-	-	2.60	084252-052x53
	7			4		11	3	2.5	3.20	084252-076x55
	4	100	36	4	25	-	-	-	2.40	084252-043x62
	5			5		-	-	-	2.50	084252-053x63
	7			4		11	3	2.5	3.10	084252-077x65
 PL (plug-in type)	4	35	21	4	10	-	-	-	2.90	084252-241x32
	5			5		-	-	-	3.10	084252-251x33
	7			4		11	3	2.5	3.95	084252-274x35
	4	60	29	4	16	-	-	-	3.30	084252-242x52
	5			5		-	-	-	3.60	084252-252x53
	7			4		11	3	2.5	4.35	084252-276x55
 AN (angle clamping)	4	35	21	4	10	-	-	-	2.93	084252-141x32
	5			5		-	-	-	3.03	084252-151x33
	7			4		11	3	2.5	3.60	084252-174x35
	4	60	29	4	16	-	-	-	3.20	084252-142x52
	5			5		-	-	-	3.40	084252-152x53
	7			4		11	3	2.5	4.00	084252-176x55
 JT (joint clamping)	4	100	36	4	25	-	-	-	3.65	084252-343x62
	5			5		-	-	-	4.04	084252-353x63
	7			4		11	3	2.5	4.82	084252-377x65
	4	140	36	4	35	-	-	-	4.03	084252-343x72
	5			5		-	-	-	4.50	084252-353x73
	7			4		11	3	2.5	5.68	084252-377x75

Expansion Joints

General Expansion Joint Data

Variations in ambient temperature coupled with the normal electrical heating of the conductors causes linear expansion. Expansion joints are used to accommodate the movement in the system caused by thermal expansion. The quantity of expansion joints required is determined by the climate and the system or segment length. Additional feeding is not required when using expansion joints as the electrical continuity of the system is not interrupted.

	Expansion joints
	Anchor point
	End feed

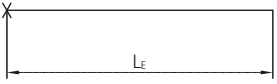
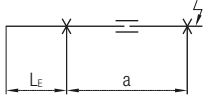
Difference in Temperature [°K]	Max. Length System PL, JT, CS, AN		
			
	Max. System Length without Expansion Joints L_E [m]	Section Length with one Expansion Joint a [m]	
	System PL, JT, CS ²⁾ and AN	System CS ²⁾	System PL, JT and AN
15	225	120	120
20	170	73	101
25	135	61	85
30	110	49	69
40	85	37	49
50	70	29	41
60	60	25	33
70	-	21	29
80	-	17	25

1) On straight track and center feed the max. system length will be doubled.
2) Max. strip insertion length on system CS; 100A-strip = 100m; 60A-strip = 200m; 35A-strip = 300m

Please note: $L_{max} = 2 \times L_E$



Longer systems can be achieved by connecting sections with expansion joints. The difference in current consumption/load at various sections of the system can effect the ideal quantity and location of expansion joints.

Example: Setting the Expansion Joint Depending on the Temperature

ΔT	Lowest ambient temperature during system operation t_{min} :	5°C	$30^\circ C = \Delta T_1$
	Ambient temp during installation t_i :	15°C	
	Highest ambient temperature during system operation t_{max} :	45°C	
Air gap read from diagram:		$s = 75 \text{ mm}$	
Air gap calculated:		$s = 100 \frac{\Delta T_1}{\Delta T} = 75 \text{ mm}$	
Installation distance K:		$K = 100 + s = 175 \text{ mm}$	

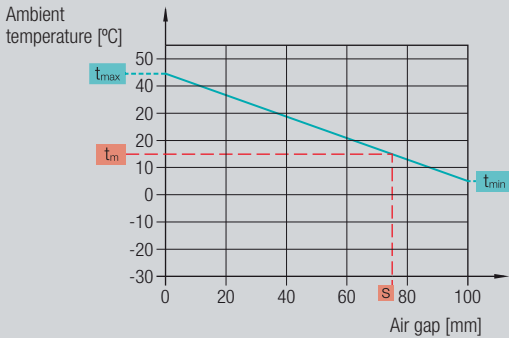

Expansion Joints

Expansion Joints (with 100 mm Expansion) for System CS (Continuous Strip)

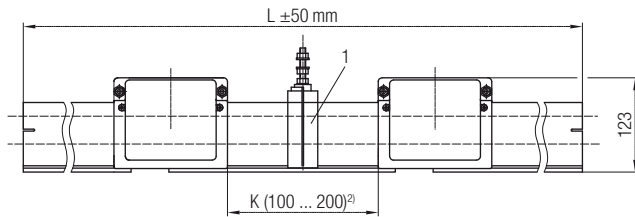

- 1) Hanger clamp to be ordered separately
2) Reference dimension K (see page 14)

Notes

- Expansion points of the support structure may influence amount and mounting position of rail expansion joints
- Conductor strips are mounted continuous

Order No.	Poles	Length L [mm]	Weight [kg]
084260-5x62	4.5	1000	1.90
084260-7x65	7.0		1.97

Expansion Joints (with 100 mm Expansion) for the Systems PL, JT and AN

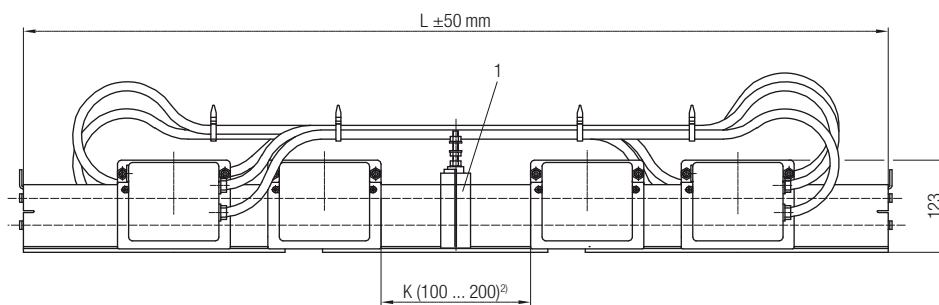

- 1) Hanger clamp to be ordered separately
2) Reference dimension K (see page 14)

System	Poles	Length L [mm]	Current [A]	Weight [kg]	Order No.	Current [A]	Weight [kg]	Order No.
PL (Plug-in Type)	4	1000	35	4.81	084261-4x32	60	4.85	084261-4x52
	5	1000		5.33	084261-5x33		5.44	084261-5x53
	7	2000		10.58	084261-7x35		11.18	084261-7x55
JT (Joint Clamping)	4	1000	100	5.11	084262-4x62	140	5.26	084262-4x72
	5	1000		5.73	084262-5x63		5.94	084262-5x73
	7	2000		11.26	084262-7x65		11.64	084262-7x75
AN (Angle Clamping)	4	1000	35	4.57	084263-4x32	60	4.67	084263-4x52
	5	1000		5.04	084263-5x33		5.17	084263-5x53
	7	2000		10.41	084263-7x35		10.74	084263-7x55

Pick-up Guides

Pick-up Guides for Transfer Points

Pick-up guides for transfer points are used for applications such as transfer switches where the collector does not entirely exit from the rail system. The pick-up serves for the introduction of the collector trolley and can compensate lateral movements of ± 8 mm and vertical deflections of ± 3 mm. We recommend adjustments below 3 mm, target 0 mm.

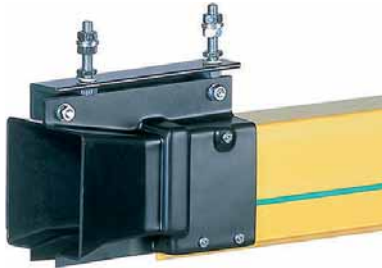

Technical details



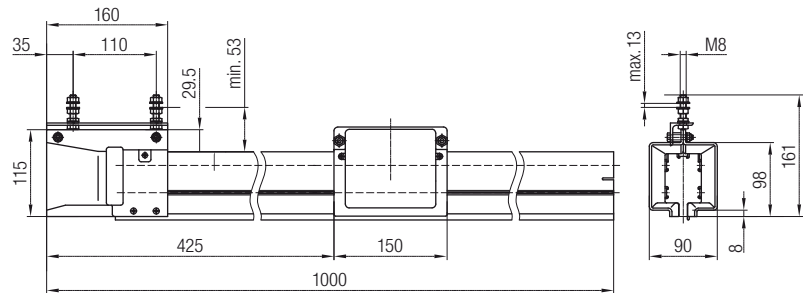

- Permissible rail misalignment:
Vertical ± 3 mm
Lateral ± 3 mm
- Pick-up guide spacing: ≤ 10 mm
- For the installation of pick-up guides apply the spring-loaded towing arm 084291-4 for the collector
- Pick-up guides can be equipped with power feeds; see description for pickup guides for transfer points
- Safety conditions (see collector)

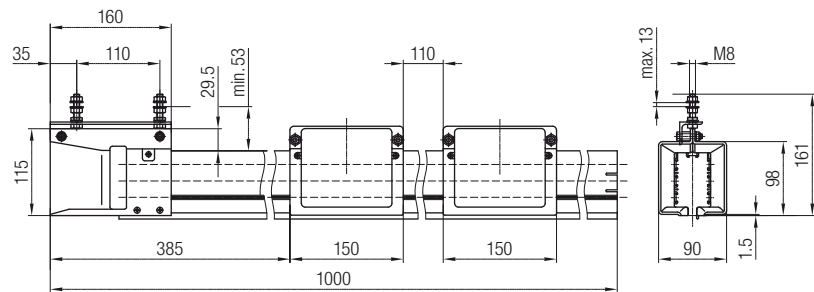

4/5 poles - type "left" for CS (continuous strip)



7 poles - type "left" for CS (continuous strip)

Pick-up Guides at Rail End	Nom. Current [A]	Type	Max. Weight [kg]	Order No.		
				4 Poles	5 Poles	7 Poles
 CS (continuous strip)	up to 100	Right	3.94	084282-5x63x01		084282-7x65x01
		Left		084282-5x63x02		084282-7x65x02
 PL (plug-in type)	35	Right	4.45	084282-4x32x11	084282-5x33x11	084282-7x35x11
		Left		084282-4x32x12	084282-5x33x12	084282-7x35x12
	60	Right	4.60	084282-4x52x11	084282-5x53x11	084282-7x55x11
		Left		084282-4x52x12	084282-5x53x12	084282-7x55x12
 AN (angle clamping)	35	Right	4.20	084282-4x32x21	084282-5x33x21	084282-7x35x21
		Left		084282-4x32x22	084282-5x33x22	084282-7x35x22
	60	Right	4.36	084282-4x52x21	084282-5x53x21	084282-7x55x21
		Left		084282-4x52x22	084282-5x53x22	084282-7x55x22
 JT (joint clamping)	100	Right	4.79	084282-4x62x31	084282-5x63x31	084282-7x65x31
		Left		084282-4x62x32	084282-5x63x32	084282-7x65x32
	140	Right	4.89	084282-4x72x31	084282-5x73x31	084282-7x75x31
		Left		084282-4x72x32	084282-5x73x32	084282-7x75x32

Conversion Retrofit Kits to Add a Power Feed Point to Pick-up Guides/Transfer Points

Order No.	Poles up to	Nom. Current [A]	Weight [kg]
084283-5	5	60	0.38
084283-7	7		0.75

Scope of delivery

Exchange cover with cable glands including connecting parts and fasteners (without cable).

Pick-up Guides

Pick-up Guides for Entrance Points

Pick-up guides for entrance points are used to guide the collector back into the system in applications where the collector has completely exited the conductor rail system. The pick-up serves for the introduction of the collector trolley and can compensate lateral offsets of ± 15 mm and a vertical deflection of ± 10 mm.

We recommend adjustment below 3 mm, target 0 mm.

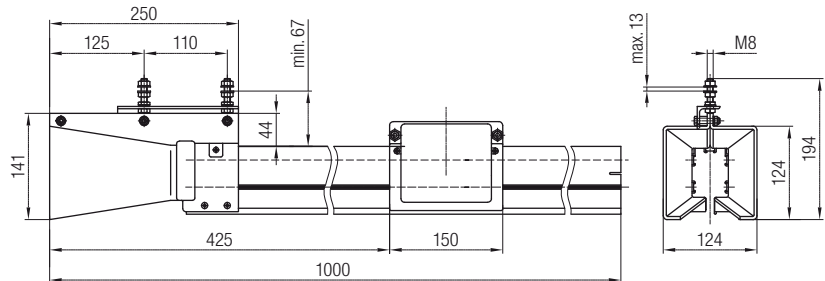
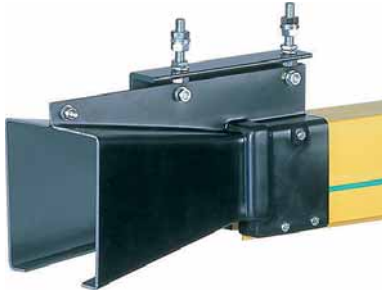



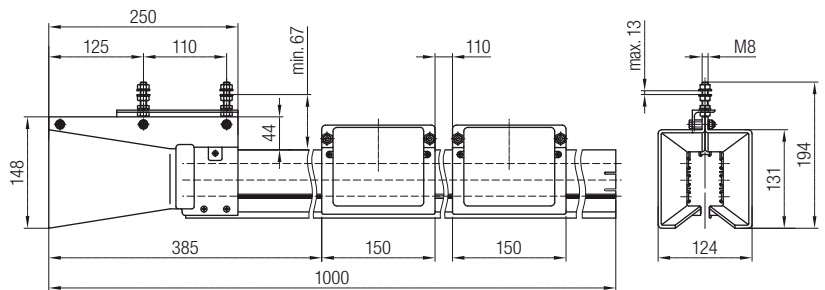

4/5 poles - type "left" for CS (continuous strip)

Technical details

- Permissible rail misalignment:
Vertical ± 3 mm
Lateral ± 3 mm
- Use spring-loaded towing arm 084291-4 for the collectors
- Pick-up guides can be equipped with feeds; see description for pick-up guides for transfer points
- Safety conditions (see collector)



7 poles - type "left" for CS (continuous strip)

Pick-up Guides at Rail End	Nom. Current [A]	Type	Max. Weight [kg]	Order No.		
				4 Poles	5 Poles	7 Poles ¹⁾
 CS (continuous strip)	100	Right	3.60	084281-5x63x01		084281-7x65x01
		Left		084281-5x63x02		084281-7x65x02
 PL (plug-in type)	35	Right	4.00	084281-4x32x11	084281-5x33x11	084281-7x35x11
		Left		084281-4x32x12	084281-5x33x12	084281-7x35x12
	60	Right	4.10	084281-4x52x11	084281-5x53x11	084281-7x55x11
		Left		084281-4x52x12	084281-5x53x12	084281-7x55x12
 AN (angle clamping)	35	Right	3.85	084281-4x32x21	084281-5x33x21	084281-7x35x21
		Left		084281-4x32x22	084281-5x33x22	084281-7x35x22
	60	Right	4.02	084281-4x52x21	084281-5x53x21	084281-7x55x21
		Left		084281-4x52x22	084281-5x53x22	084281-7x55x22
 JT (joint clamping)	100	Right	4.30	084281-4x62x31	084281-5x63x31	084281-7x65x31
		Left		084281-4x62x32	084281-5x63x32	084281-7x65x32
	140	Right	4.40	084281-4x72x31	084281-5x73x31	084281-7x75x31
		Left		084281-4x72x32	084281-5x73x32	084281-7x75x32

1) 7 poles on request. The different types depend on the different system parameters. Use our technical support to plan the design

Pick-up Working Range

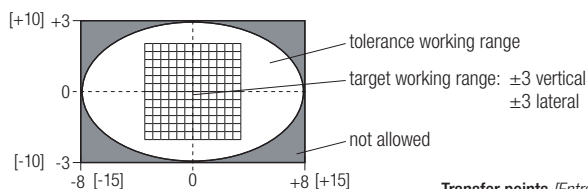

Transfer points [Entrance points]; all measurements in mm

Collectors and Accessories

Collector with Connection Cable



Collector up to 5 poles

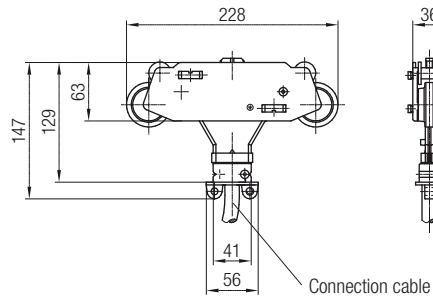

Connection cable



Collector up to 7 poles

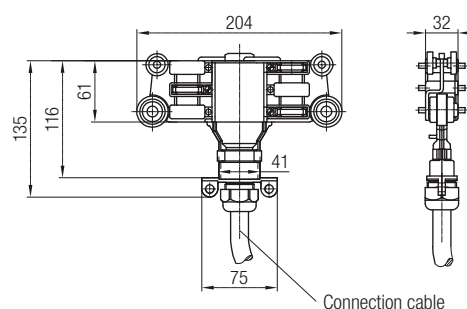

Connection cable

Poles	Nom. Current at 60% ED [A]	Cable Cross Section [mm ²]	Length = 1 m		Connection Cable Length = 3 m		Length = 5 m	
			Order No.	Weight [kg]	Order No.	Weight [kg]	Order No.	Weight [kg]
4	25	2.5	084201-4x11	0.58	084201-4x13	1.00	084201-4x15	1.30
	40	4.0	084201-4x21	0.71	084201-4x23	1.27	084201-4x25	1.57
5	25	2.5	084201-5x11	0.63	084201-5x13	1.17	084201-5x15	1.47
	40	4.0	084201-5x21	0.80	084201-5x23	1.52	084201-5x25	1.92
7	25	2.5	084203-7x11x01	0.82	084203-7x13x01	1.28	084203-7x15x01	1.58
	40	4.0	084203-7x21x01	1.07	084203-7x23x01	1.37	084203-7x25x01	1.65

Technical details

- Cable length: 1, 3 and 5 m for connection to the terminal box provided by the customer
- Collector shoe material: copper graphite
- Alternative cable for low temperature on request
- Conductor rail radius: horizontal arrangement: $R_{min} = 2750$ mm
vertical arrangement: $R_{min} = 5000$ mm

Double Collector

For the joining of identical single collectors to create a dual collector arrangement, we can provide the **towing arm crossbar Order No. 084291-3**

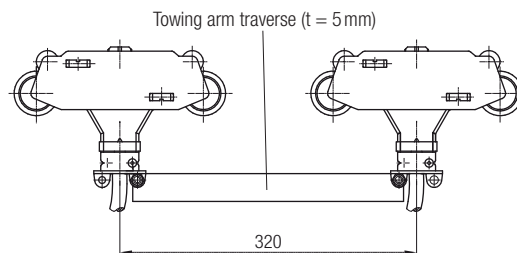

Note

A sufficient quantity of collectors must be used in arrangements that contain pick-up guides or isolations sections to ensure that collectors are not overloaded as other collectors exit the system (i.e. at pick-up guides).

Collectors and Accessories

Collector up to 7 Poles; with Single Cores in a Flexible Conduit

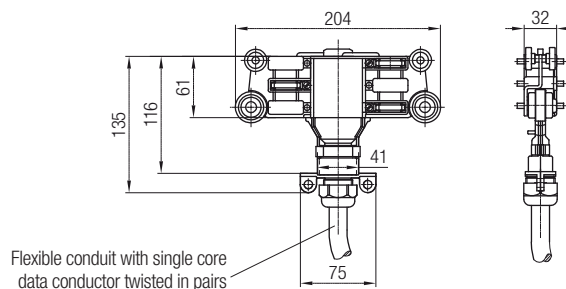

Poles	Nom. Current at 60% ED [A]	Cable Cross Section [mm ²]	Corrugated Hose					
			Length = 1 m		Length = 3 m		Length = 5 m	
			Order No.	Weight [kg]	Order No.	Weight [kg]	Order No.	Weight [kg]
6	25	2.5	084203-6x31x02	0.80	084203-6x33x02	1.30	084203-6x35x02	1.59
	40	4.0	084203-6x41x02	0.82	084203-6x43x02	1.35	084203-6x45x02	1.64
7	25	2.5	084203-7x31x02	0.85	084203-7x33x02	1.30	084203-7x35x02	1.59
	40	4.0	084203-7x41x02	1.09	084203-7x43x02	1.39	084203-7x45x02	1.69

Technical details

- Collector for data transmission e.g. in connection with Conductix-Wampfler powertrans system
- Carbon material for energy: 4 x copper graphite
- Collector shoe material: copper graphite, 2 (3) x silver graphite (6 poles: ⑤, ⑥; 7 poles: ④, ⑤, ⑥)

Note

To increase the contact reliability or for applications with transfers, double collectors should be used with the crossbar (order No. 084291-3). Please note the general advice for double collectors (preceding page).

Towing Arm



Chain towing arm

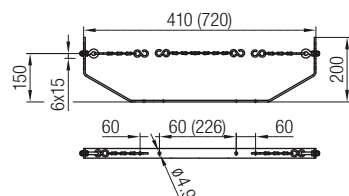

Order No.	Type	a [mm]	Material	Weight [kg]
084291-11	Simple	410	Steel, galvanized	0.89
084291-12	Double	720		1.28

Notes

- Horizontal and vertical installation possible
- Not suited for use with transfers
- Hints for application see page 2



Fork-type towing arm

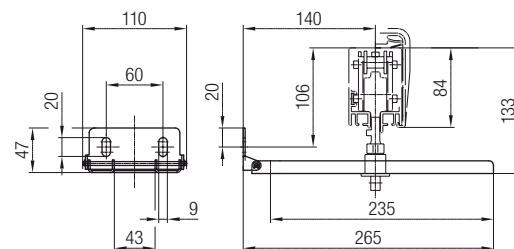

Order No. 084291-2

Technical details

- Material: steel, galvanized
- Weight: 0.37 kg

Notes

- Only for one collector
- Hints for application see page 2

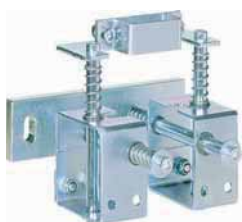

Spring-loaded towing arm

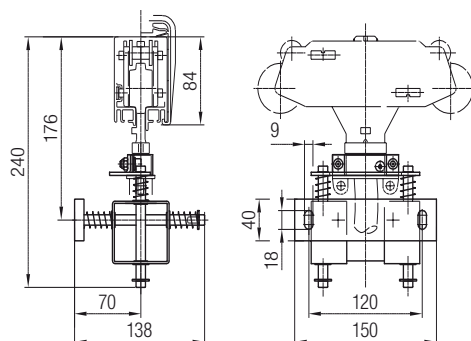

Order No. 084291-4

Technical details

- Material: steel, galvanized
- Weight: 1.16 kg
- Max lateral misalignment: ± 15 mm
- Max lateral misalignment: ± 10 mm
- For use with pick-up guides
- Strengthening brackets recommended at a distance of 250 mm
- Further spring-loaded towing arms on request



Wear Parts and Accessories

Sealing Lip

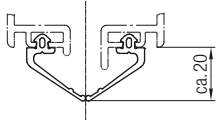

Order No. 084293-1

Technical details

- Material: EPDM
- Weight: 0.21 kg
- Piece goods (lip pair)

Notes

- Optimum accessories for a better protection against impurities and humidity, e.g. driving rain
- The lip insertion tool (Order No. 084293-4) is required for assembly

Reinforcing Bracket for Plastic Housing and Storm Safety Device



Order No.	Material	Weight [kg]
084295-1	Steel, galvanized	0.08
08.S280-0564 ¹⁾		0.09

Note

The reinforcing brackets serve to improve the profile rigidity, e.g. in the area of the vertical curves

¹⁾ With additional safety rope as storm safety device. Shall be provided on every second rail.

Conversion Retrofit Kits to Add a Power Feed Point to Pick-up Guides/Transfer Points

Order No.	Poles up to	Nom. Current [A]	Weight [kg]
084283-5	5	60	0.38
084283-7	7		0.75

Scope of delivery

Exchange covers with cable glands including connecting material and fasteners (without cable)

Half Shells



Half shells for pick-up guides



Half shells for transfer points

Order No. Half Shell "Left"	Order No. Half Shell "Right"	Poles	Material	Weight [kg]
08-E011-0163	08-E011-0162	4 / 5	Plastic	0.14
08-E011-0180	08-E011-0179	7		0.14

Order No. Half Shell "Left"	Order No. Half Shell "Right"	Poles	Material	Weight [kg]
08-E011-0165	08-E011-0164	4 / 5	Plastic	0.06
08-E011-0182	08-E011-0181	7		0.06

Notes

- All pick-up units are equipped with replaceable half shells
- Replacement of the complete pick up unit not needed

Collectors Shoes for Collectors



(C)
4+5 poles collectors shoes



(A)



(B)

6+7 poles collectors shoes

Order No.	Nom. Current 60% ED [A]	Material	Type of Construction	Installation Position	Weight [kg]
081007-212	25	Copper graphite	C	L1, - L3, PE, 4	0.14
081007-111	40		A	L1 - L3, PE, ⑤+⑥	
081007-113	40		B	④	
081007-114	40	Ag-Graphit	A	DATA ⑤+⑥	
08-K154-0261	10		B	DATA ④	
08-K154-0262	10				

For order of replacement carbon collector shoes, please observe type of construction, place of installation and amperage.

Cu = copper

Ag = silver

Assembly Tools

Strip Insertion Trolley for System CS (Continuous Strip)

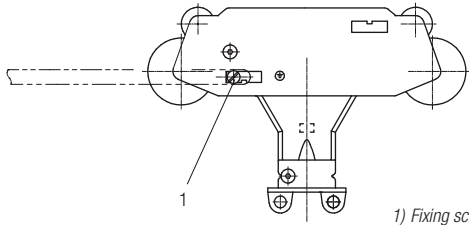

1) Fixing screw for current strip (do not pull tight)

Order No.	Poles up to	Weight [kg]
084292-1x5	5	0.22
084292-1x7	7	0.24

De-coil Unit for Simplified Strip Insertion - Optional (System CS)



Order No.	Datametal	Strip Type			Weight [kg]
		35A	60A	100A	
08-V015-0404	$40 \leq L \leq 130$ m	$40 \leq L \leq 130$ m	$40 \leq L \leq 65$ m	$30 \leq L \leq 40$ m	2.77
08-V015-0403	$130 \leq L \leq 300$ m	$130 \leq L \leq 300$ m	$65 \leq L \leq 200$ m	$40 \leq L \leq 100$ m	6.15
08-W100-0561	Standard rate for current strip				

Note

For easy installation of current strips specially "100A"-strip.

Bending Device for Chamfering the Copper Strip for System AN (Angle Clamping)



Order No. 084295-4

Technical detail
Weight: 0.05 kg

Positioning Block for System AN (Angle Clamping)



Order No.	Poles	Material	Weight [kg]
084295-2	5	Plastic	0.38
084295-3	7		

Note

The positioning block serves as a counter point for the assembly of the connecting position and avoids any offset of the contact strip.

Insertion Tool for Sealing Lip

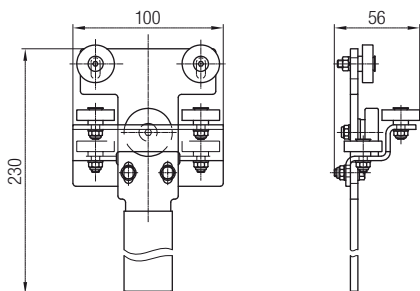

Order No. 084293-4

Technical details

- Article: insertion tool
- Weight: 0.60 kg

Notes

- Mounting tool to insert the optional sealing lip
- The use of a weak soap and water or a mineral oil free lubricant can be used to aid in the insertion of the sealing lips

Assembly Tools

Support Arm (Optional)

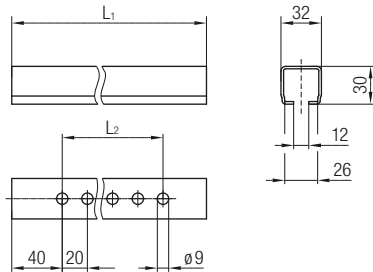

Use with
hanger and anchor clamps with steel square nut

Order No.	L ₁ [mm]	L ₂ [mm]	Material	Weight [kg]
020185-0250	250	200	Steel, galvanized	0.39
020185-0315	315	260		0.50
020185-0400	400	340		0.63
020185-0500	500	340		0.78

Girder Clip (Optional)

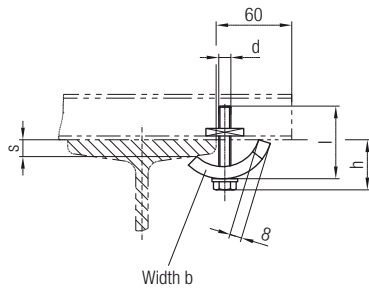

Use with
for rail and anchor clamps with groove stone

Order No.	s ¹⁾ [mm]	d [mm]	l [mm]	h ²⁾ [mm]	b [mm]	Material	Weight [kg]
020181-08	6 - 25	M8	50	31 - 40	30	Plate and fasteners: steel, galvanized	0.15
020180-08x36	18 - 36		65	42 - 60		Bracket: steel, galvanized	0.22

1) Support distance
2) Installation height

Weld-on Bracket for Support Arm (Optional)

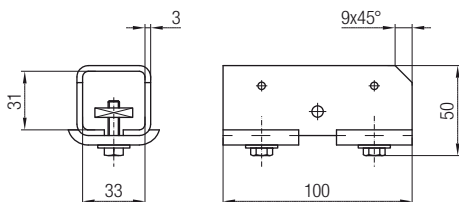





Order No. 020285

Technical details

- Material:
 - Bracket: steel, unfinished
 - Plate and fasteners: steel, galvanized;
- Weight: 0.42 kg

Program Overview

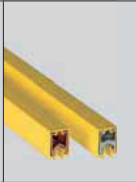
Conductor Rails

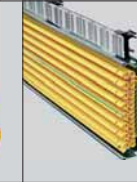
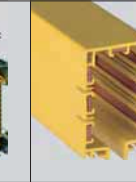
System Designs	Single Pole Insulated Conductor Rail				Multipole Conductor Rail		Enclosed Conductor Rail	
Conductor Rail System	Progr. 0811	Progr. 0815	Progr. 0812	Progr. 0813	Progr. 0831	Progr. 0832	Progr. 0842	
								
Nominal Current ¹⁾	[A]	10-100	100	25-400	200-1250	10-125 ³⁾	25-200 ⁴⁾	35-140 ⁵⁾
Voltage Grade	[V]	500	500	660	660	500	690	600
Support Spacing	[m]	0.4-1.0	0.5	1.5	2.5	1	3.2	2
Rail Length ²⁾	[mm]	4000	4000	4000	5000	4000	4000	4000
Outside-Dimensions	[mm]	14.7 x 15.5	9.6 x 15.2	18 x 26	32 x 42	3-pol.: 26 x 62 4-pol.: 26 x 80 5-pol.: 26 x 98	4-pol.: 200 x 50	5-pol.: 56 x 90 7-pol.: 56 x 90

1) At 100% duty cycle; and 35°C; 2) Standard; 3) 140A at 80% duty cycle; 4) 200A at 80% duty cycle; 5) 160A at 80% duty cycle

General Hints

We reserve the right to carry out any modification of the product at any time in the course of technical progress without prior notice.
 According to the EC machinery directive, conductor bars are considered as incomplete machines. Commissioning is only permitted, if the superior machine where the conductor rail is installed, complies with the regulations.
 Our general terms of business have to be observed. We will be pleased to send these to you on request.
 Reprint, even of extracts, is only permitted with our approval.

Your Applications - our Solutions!

Conductor Rails by Conductix-Wampfler represent only one of the many solutions made possible by the broad spectrum of Conductix-Wampfler components for the transport of energy, data and fluid media. The solutions we deliver for your applications are based on your specific requirements. In many cases, a combination of several different Conductix-Wampfler systems can prove advantageous. You can count on all of Conductix-Wampfler's Business Units for hands-on engineering support - coupled with the perfect solution to meet your energy management and control needs.



Cable reels

Motorized reels and spring reels by Conductix-Wampfler hold their own wherever energy, data and media have to cover the most diverse distances within a short amount of time - in all directions, fast and safe.



Festoon systems

It's hard to imagine Conductix-Wampfler cable trolleys not being used in virtually every industrial application. They're reliable and robust and available in an enormous variety of dimensions and designs.



Conductor rails

Whether they're enclosed conductor rails or expandable single-pole systems, the proven conductor rails by Conductix-Wampfler reliably move people and material.



Non-insulated conductor rails

Extremely robust, non-insulated conductor rails with copper heads or stainless steel surfaces provide the ideal basis for rough applications, for example in steel mills or shipyards.



Energy guiding chains

The "Jack of all trades" when it comes to transferring energy, data, air and fluid hoses. With their wide range, these energy guiding chains are the ideal solution for many industrial applications.



Slip ring assemblies

Whenever things are really "moving in circles", the proven slip ring assemblies by Conductix-Wampfler ensure the flawless transfer of energy and data. Here, everything revolves around flexibility and reliability!



Inductive Power Transfer IPT®

The no-contact system for transferring energy and data. For all tasks that depend on high speeds and absolute resistance to wear.



Reels, retractors and balancers

Whether for hoses or cables, as classical reels or high-precision positioning aids for tools, our range of reels and spring balancers take the load off your shoulders.



Jib boom

Complete with tool transporters, reels, or an entire media supply system - here, safety and flexibility are key to the completion of difficult tasks.



Conveyor systems

Whether manual, semiautomatic or with Power & Free – flexibility is achieved with full customization concerning layout and location.

www.conductix.com

Conductix-Wampfler AG

Rheinstrasse 27+33
79576 Weil am Rhein
Germany

Hotline

Phone +49 (0) 7621 662-222

Phone +49 (0) 7621 662-0

Fax +49 (0) 7621 662-144

info.de@conductix.com

www.conductix.com



DELACHAUX GROUP