

Deyle Power

Deyle Trolley Bus Bar B

The rugged industrial trolley bus bar.

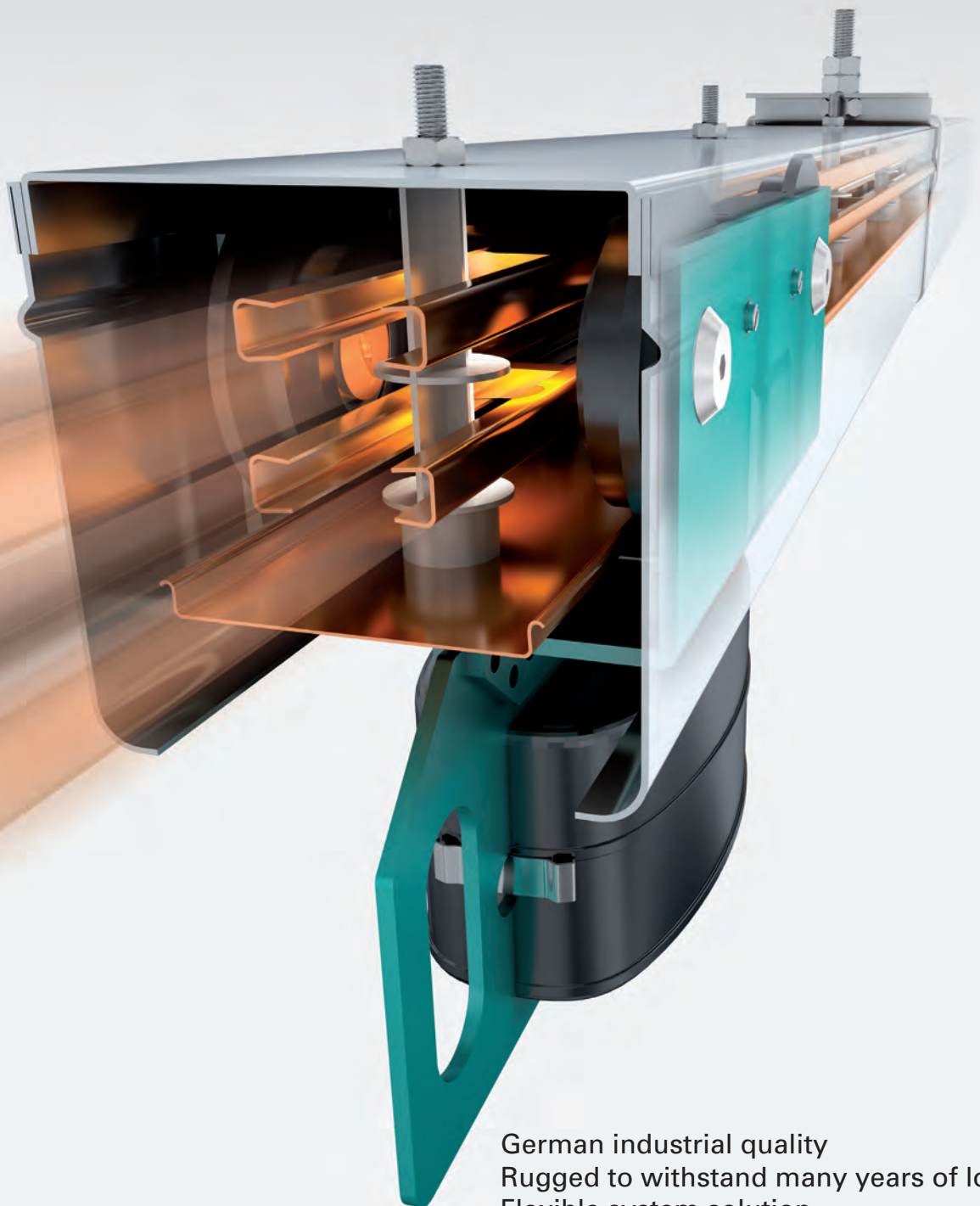

German industrial quality
Rugged to withstand many years of load
Flexible system solution
Easy installation and servicing

The premium class industrial trolley bus bar

In cost-effective use at the most demanding addresses for many years

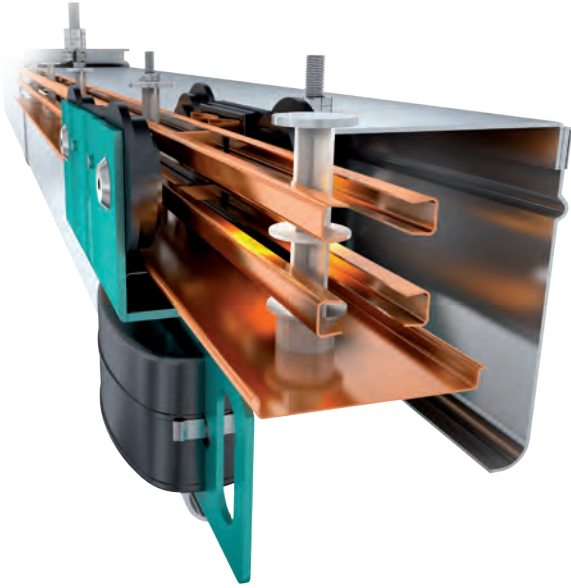

Designed for rugged use in production, the Deyle industrial trolley bus bar B is built as stable steel sheet housing to withstand even extreme loads. And our installed testimonial systems have proven that they withstand them for decades. This is also true for our trolleys which are equipped with top-grade ball bearings. The bus bar design allows for a lateral tilt of 30 degrees. The bus bar features copper rails which are open inside for an unrestricted thermal expansion to ensure the bus bar's full performance, especially in conditions of changing temperatures. This is crucial for installations over longer distances – full touch protection in compliance with VDE regulations included. The solid design allows for suspension spans of up to 3 metres, reducing the installation effort. The standard hot-dip galvanized surface can also be powder-coated in all RAL colours as customer option.

BAN3-50	BAN5-50	BAN7-50	RAN9-50	RAN11-50
BAN3-100	BAN5-100	BAN7-100	RAN9-100	RAN11-100

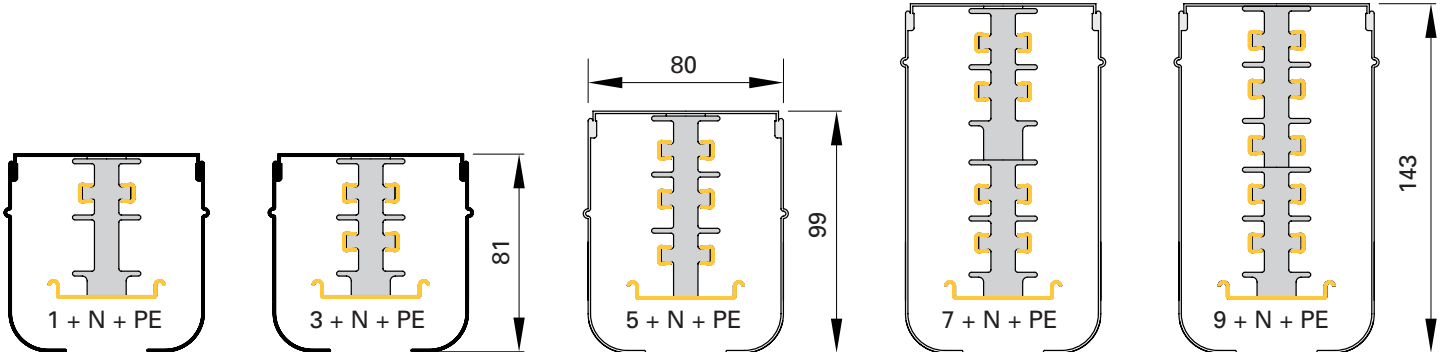

Amperage	50 A	100 A
Technical data	Type B/R	
Number of poles	1+N+PE, 3+N+PE, 5+N+PE, 7+N+PE, 9+N+PE	
Protection class	IP 50 / IP 53 on request	
Standard	DIN VDE 0660 Part 502, IEC 439-1 and -2 EN 60439 Part 1 and 2, DIN 57100	
Nominal voltage	500 V	
Nominal current of trolley	16 A – 100 A	
Standard lengths	1 m, 4 m	
Customised lengths	0.3 m to 4 m	
Suspension span	2–3 m	
Housing profile	Steel, sendzimir galvanized	
Temperature range	Trolley: -30°C to +70°C Bar: -30°C to +90°C	
Travel speed	max. 7 m/sec.	

Bars with more poles, e.g. for test sections, on request.



The Deyle System B: Your advantages at a glance.

Suspension span of up to
3 metres.

Rugged and powerful – for up to
100 amperes per collector.

Easy connection system for fast
installation.

Indestructible steel housing for
rough environments.

Completely pre-assembled units –
slide in and go.

Safe touch protection due to
inside 250 mm long
insulating stretch.

Head or in-line feeding.

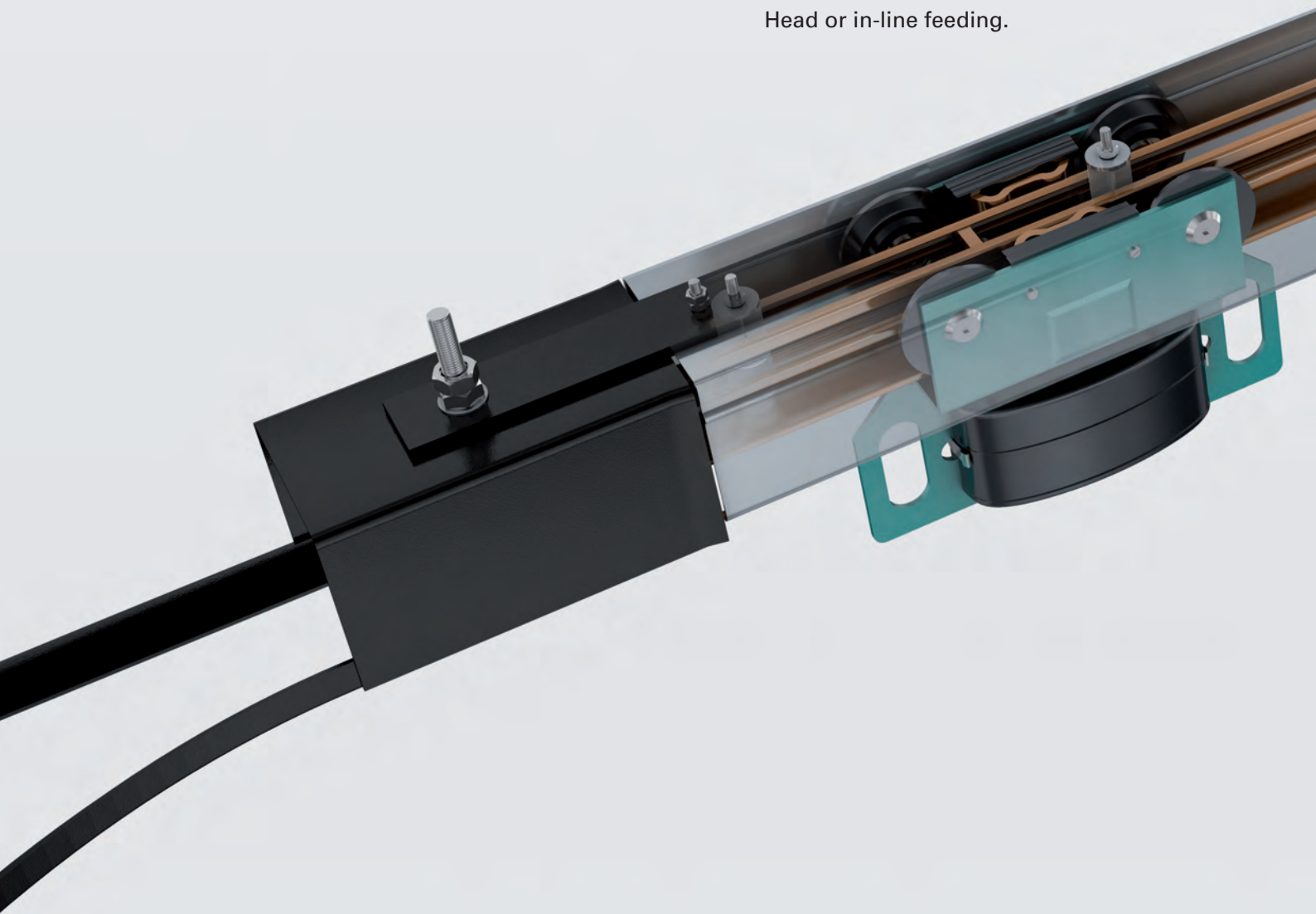

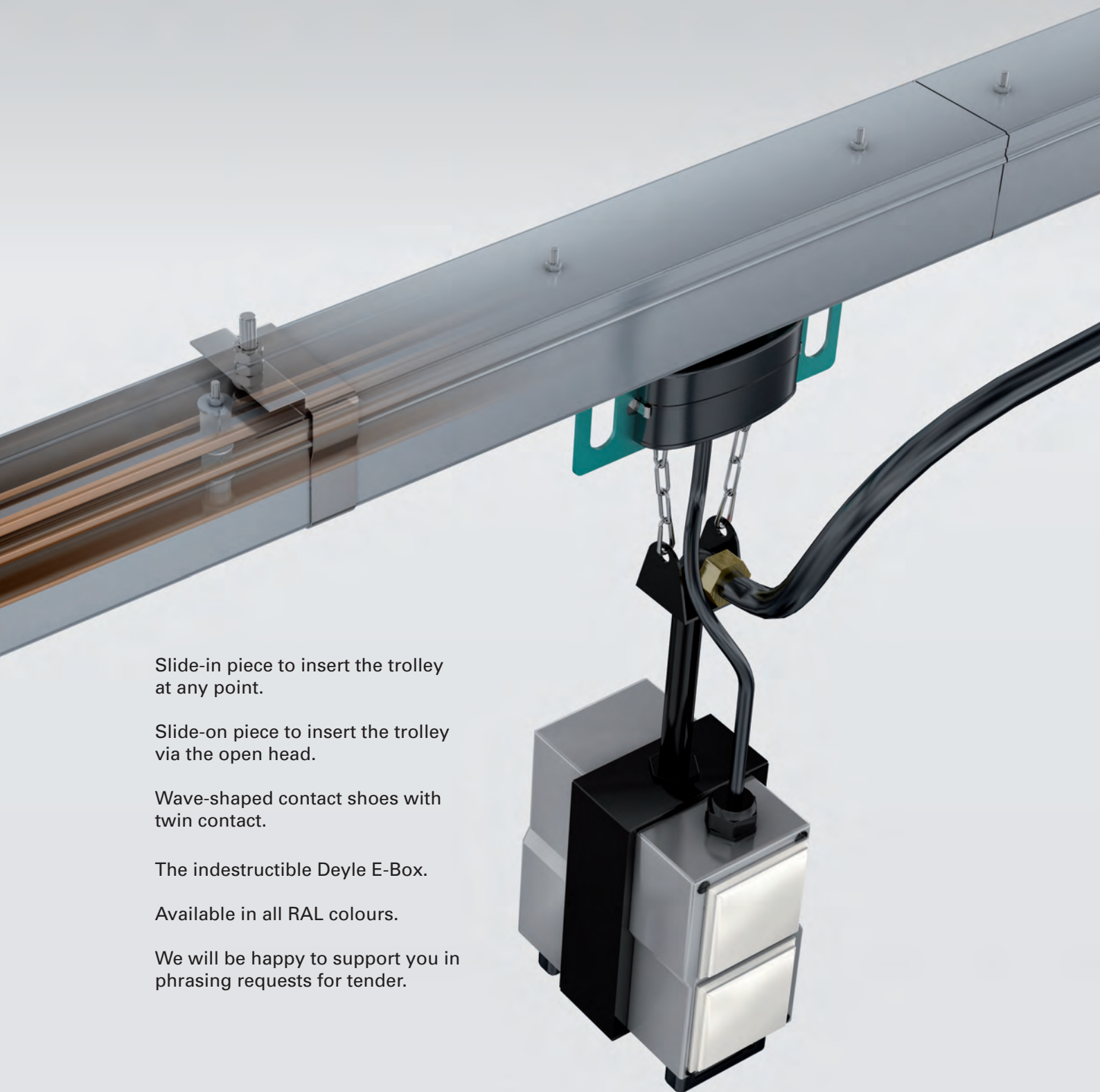

Slide-in piece to insert the trolley at any point.

Slide-on piece to insert the trolley via the open head.

Wave-shaped contact shoes with twin contact.

The indestructible Deyle E-Box.

Available in all RAL colours.

We will be happy to support you in phrasing requests for tender.

We have the trolley bus bar system, which you need.

The Deyle bus bar trolley. Rugged without compromise, bespoke design.

The low-maintenance Deyle bus bar trolleys have high-grade ball bearings to make them virtually indestructible. Due to their wave-shaped contact shoes with twin contact, they run smoothly in the trolley bus bar, making them the first choice in production, laboratories and workshops. They ensure a reliable contact and a long service life. Up to 100 amperes per collector are possible.

Take your pick at Deyle. The better tailored to your needs, the better, safer and more efficient your system solution will work. This is why we offer a selection of system modules for the trolleys, fuses, collectors and the installation. We cannot show you all here – but we can surely deliver them. Ask us for your customised system solution.

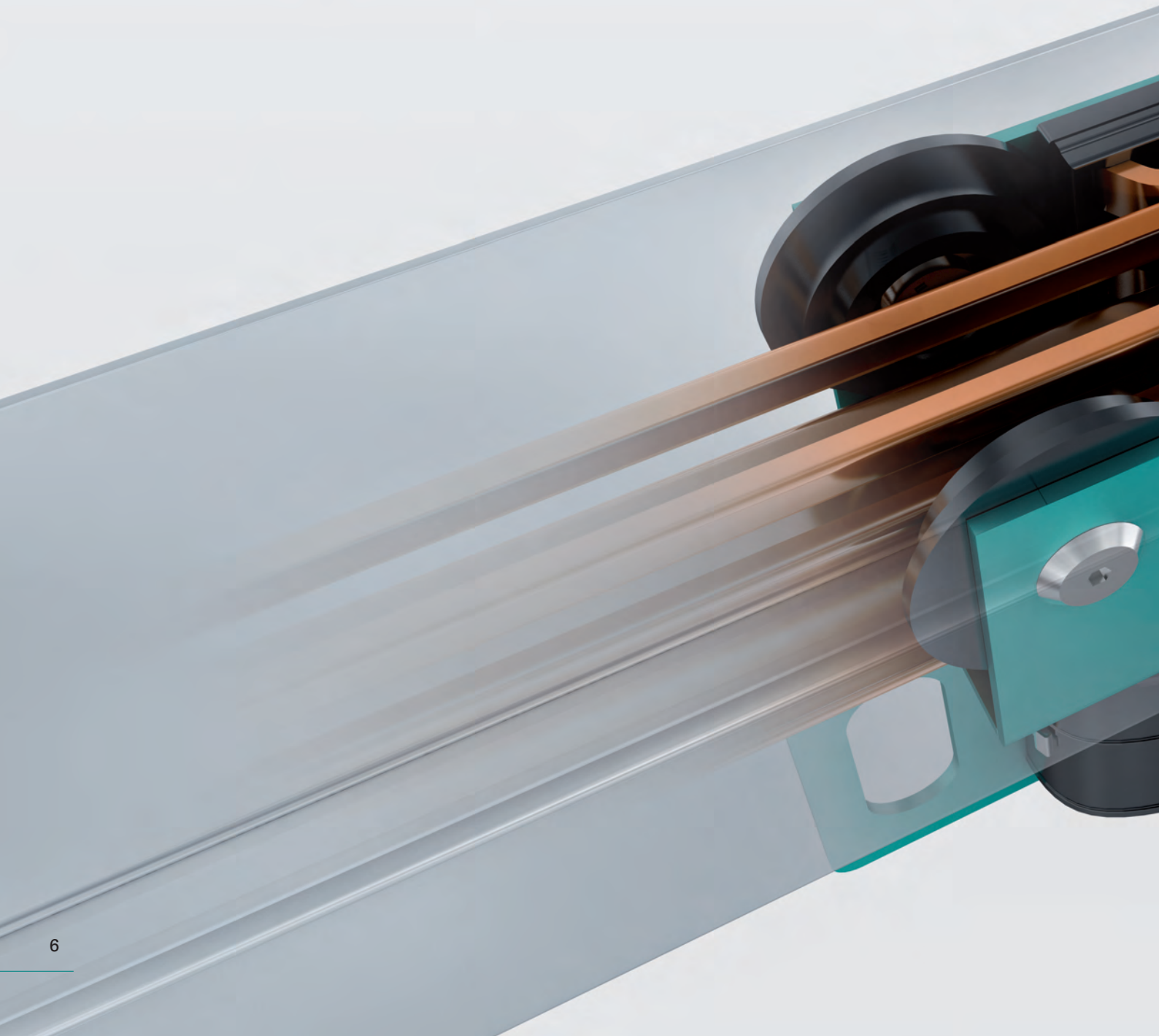

DEYLE
power all down the line

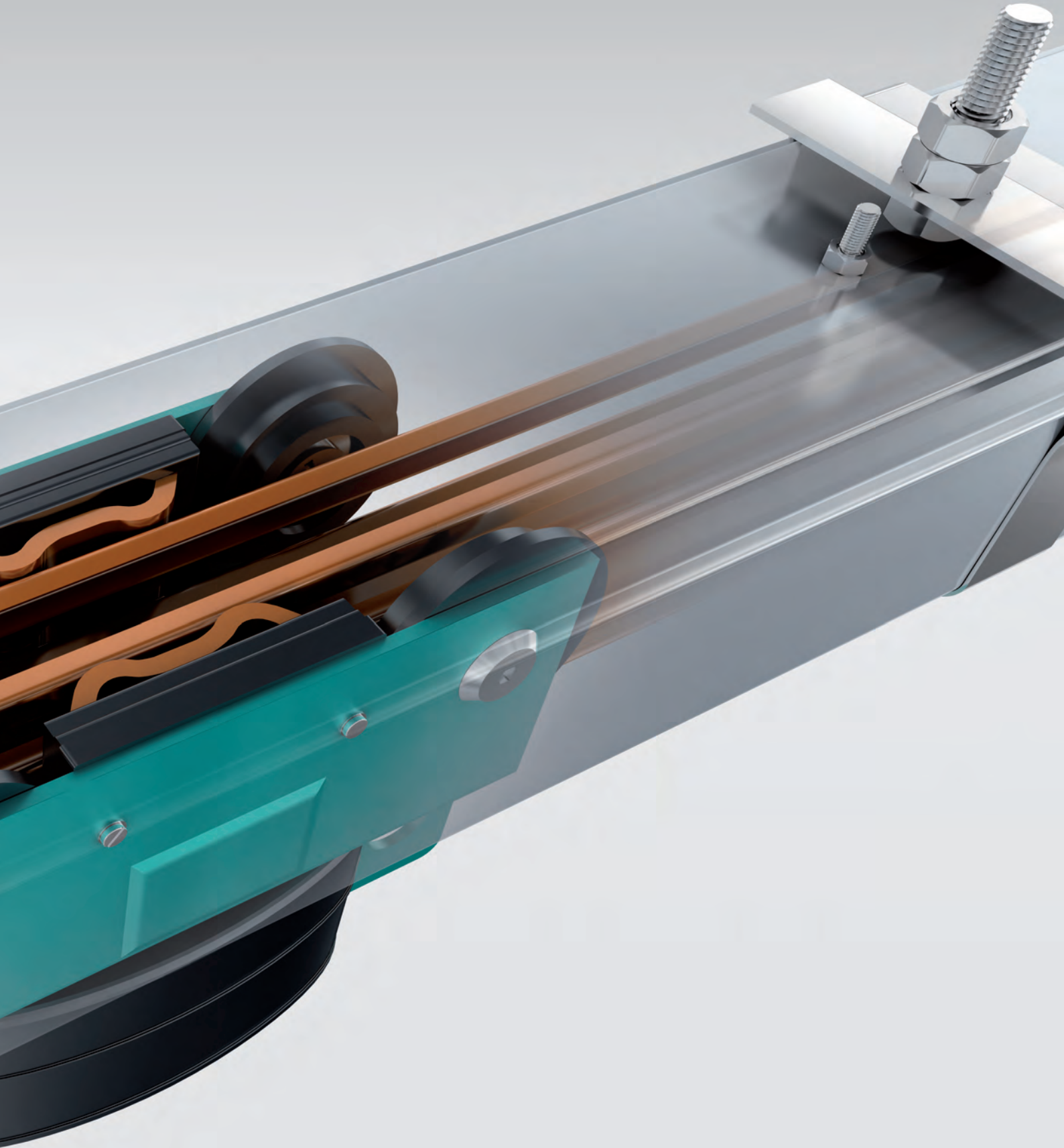

The Deyle bus bar trolley

Rugged without compromise, bespoke design.

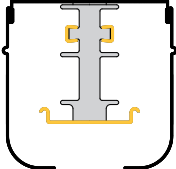
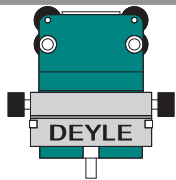
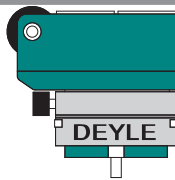
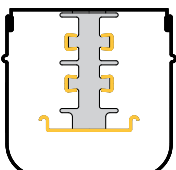
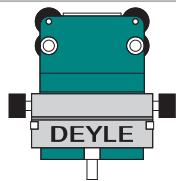
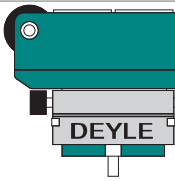
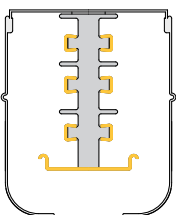
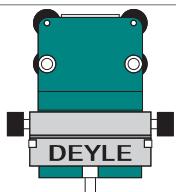
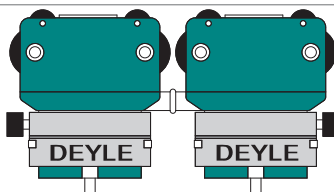
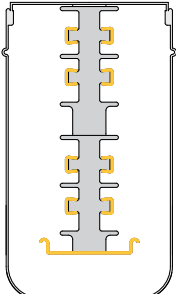
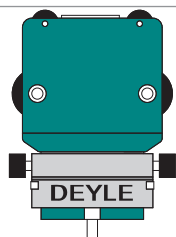
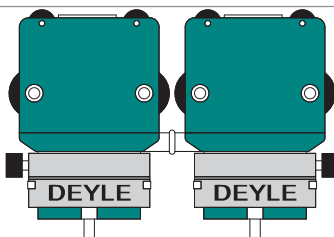
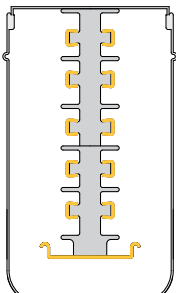
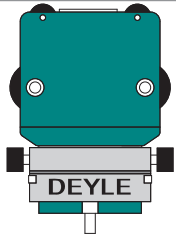
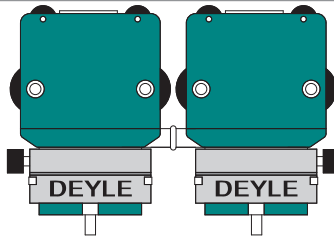
	Curve trolley for radii smaller than 1 metre	Smooth-running trolley in standard size	Wide smooth-running trolley
1+N+PE BAN3-		 BEK3-20E 20A	 BEN3-40EL 40A
3+N+PE BAN5-		 BEK5-20E 20A	 BEN5-40EL 40A
5+N+PE BAN7-		 BEK7-20E 20A	 BEN7-40DL 40A
7+N+PE RAN9-		 REN9-20EL 20A	 REN9-40DL 40A
9+N+PE RAN11-		 REN11-20EL 20A	 REN11-40DL 40A

Wide
smooth-running
trolley compound

- BEN3-20E
- Trolley bus bar B
 - N = Normal
 - K = Compact (Kompakt)
 - S = Fused (Sicherung)
 - Number of poles
 - Current strength
 - E = Single trolley (Einfachwagen)
 - D = Double trolley (Doppelwagen)

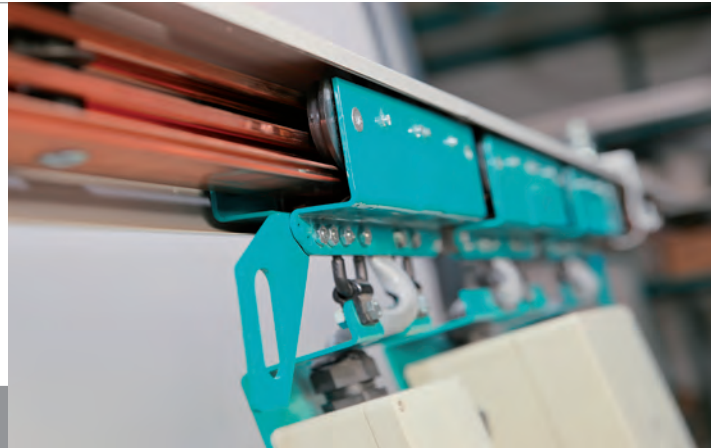
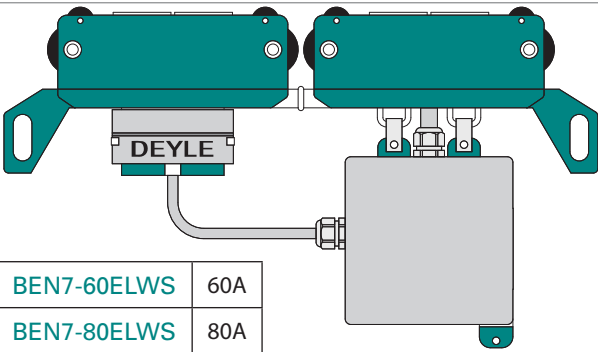
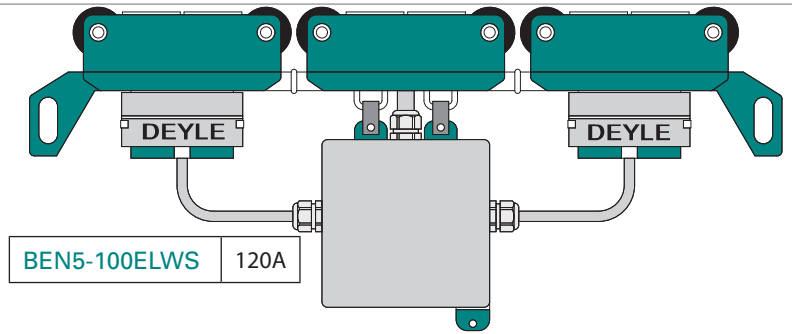
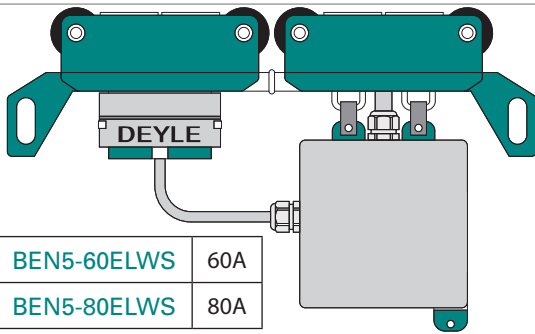

Curves

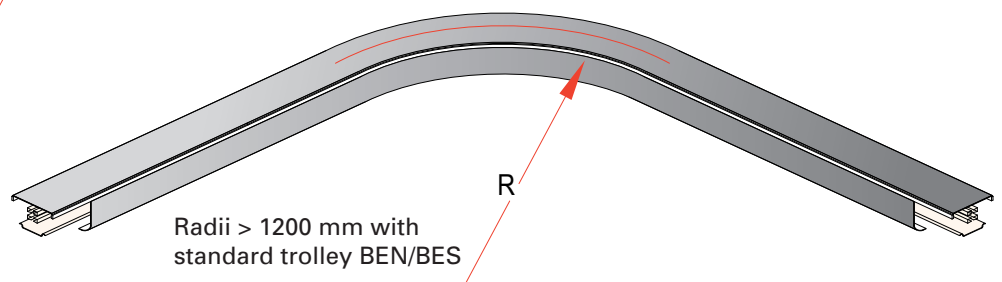
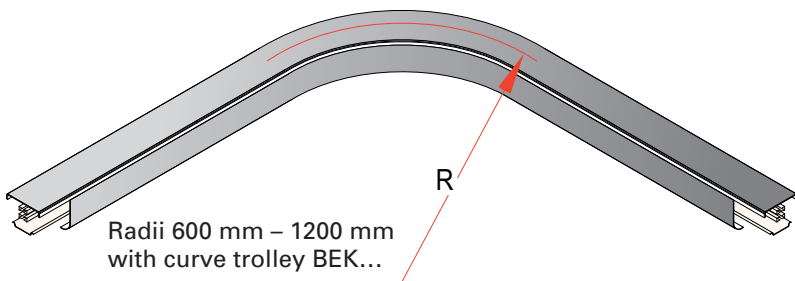

Accessories for bus bar trolleys without fuse box

Towing plate
instead of rubber buffer

Pair of sensors for cross-
over unit for BEN/BES

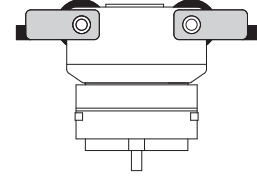
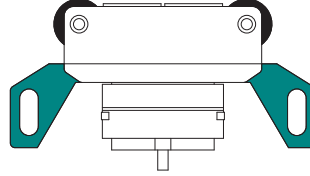
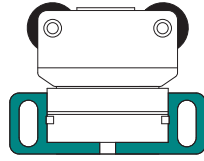
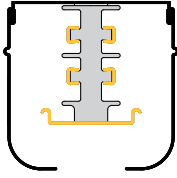

BZMN1-B/R

BZMN2-B/R

OZFÜ

Dummy trolley with rotating
clamp to transport cables and
air hoses

Trolley with mounting plate
for balancers, cable drums,
etc.

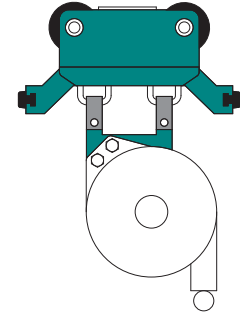
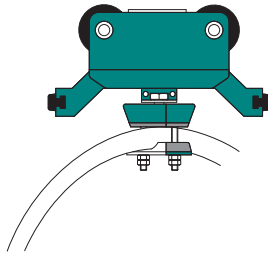
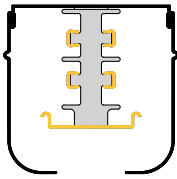

BEN-PNEU1

BEN3-20ELTR 1+N+PE

BEN5-20ELTR 3+N+PE

Various socket trolleys for
three-phase current

Only for
3+N+PE
BAN5-

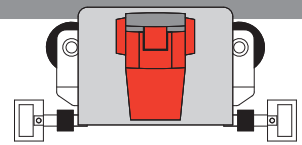
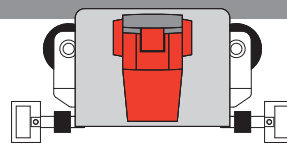
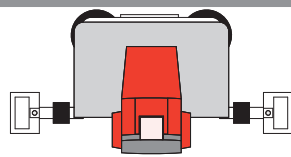
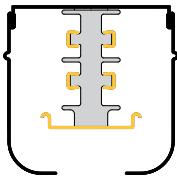

BEN5-20/16WCL 16A

BEN5-40/16WCL 16A

BEN5-40/32WCL 32A

Twin contact shoe set for
secured power transmis-
sion at high speeds



Deyle builds your custom bus bar trolley. Whatever you need: We integrate balancers, cable drums or cable brakes. We aim at your efficiency – for greater profitability and safety.

Flexible towing arm on trolley for cross-overs

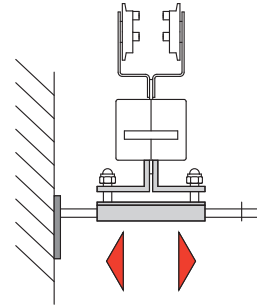
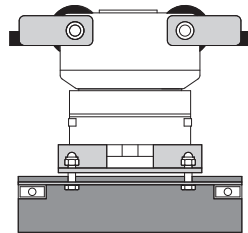

BEN5-20DAI



Deyle bus bar trolleys with fuse box

A fuse box directly on the bus bar trolley offers many advantages: You can, for instance, switch off specific collectors or remove trouble incidents directly on site.

Bus bar trolleys with fuse box for radii from >600 to <1200 mm

1+N+PE
BAN3-

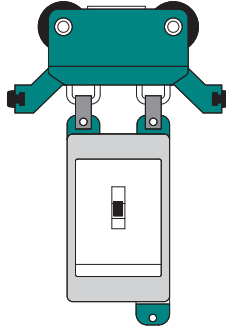
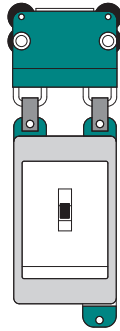
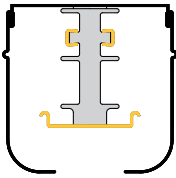

BESK3-16AWS1	16A
--------------	-----

BES3-16AWS1	16A
-------------	-----

3+N+PE
BAN5-

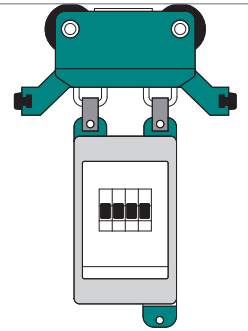
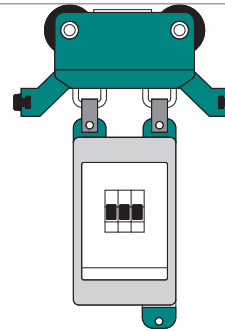
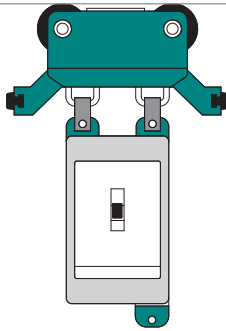
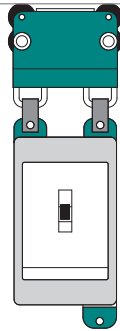
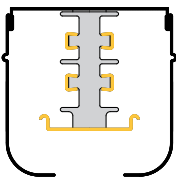

BESK5-16AWS	16A
-------------	-----

BES5-16ALWS1	16A
--------------	-----

BES5-16ALWS	16A
-------------	-----

BES5-16ALWS4	16A
--------------	-----

3+N+PE
BAN5-

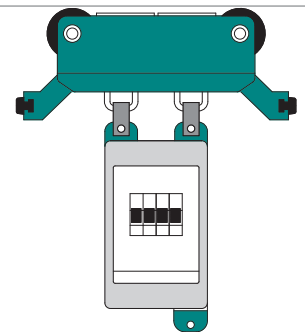
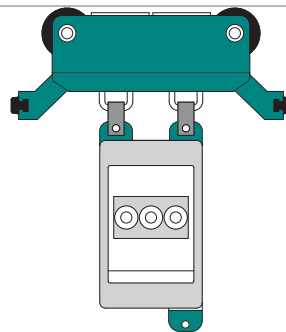
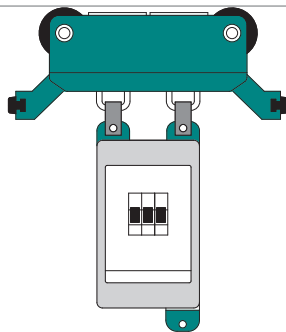
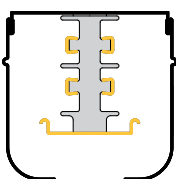

BES5-32ALWS	32A
BES5-40ALWS	40 A

BES5-35PLWS	35A
-------------	-----

BES5-32ALWS4	32A
--------------	-----

Fused trolleys for bus bars 5+N+PE,
7+N+PE, 9+N+PE on request.

Accessories for bus bar trolleys with fuse box



Towing plate instead of rubber buffer only for stretched trolley variant

Sensor for cross-over unit for all BEN/BES

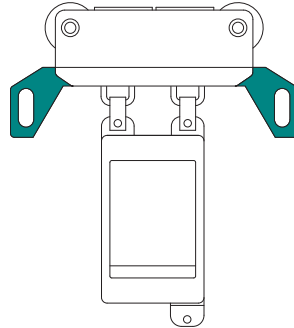

BZMN1-B/R

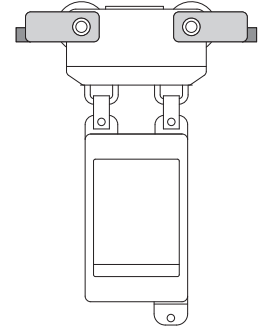

OZFÜ

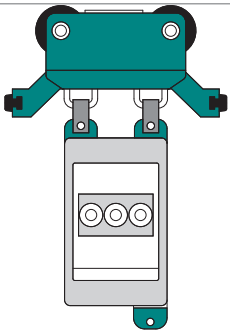

BES5-16PLWS 16A

BES3-20E

- Trolley bus bar B
- N = Normal
- K = Compact (**Kompakt**)
- S = Fused (**Sicherung**)
- Number of poles
- Current strength
- E = Single trolley (**Einfachwagen**)
- D = Double trolley (**Doppelwagen**)

ALWS

- A = Automatic circuit breaker
- P = Cartridge fuse (**Patronensicherung**)
- WS = Angled hinge (**Winkelscharnier**)

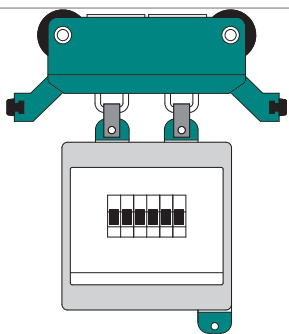

BES5-32ALWS6 32A

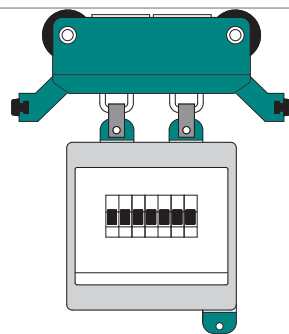

BES5-32ALWS7 32A

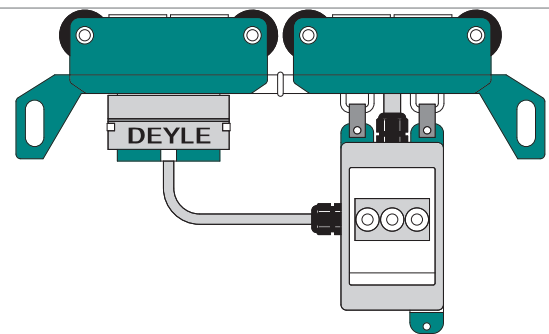

BES5-63PLWS 35A

The Deyle mounting system.

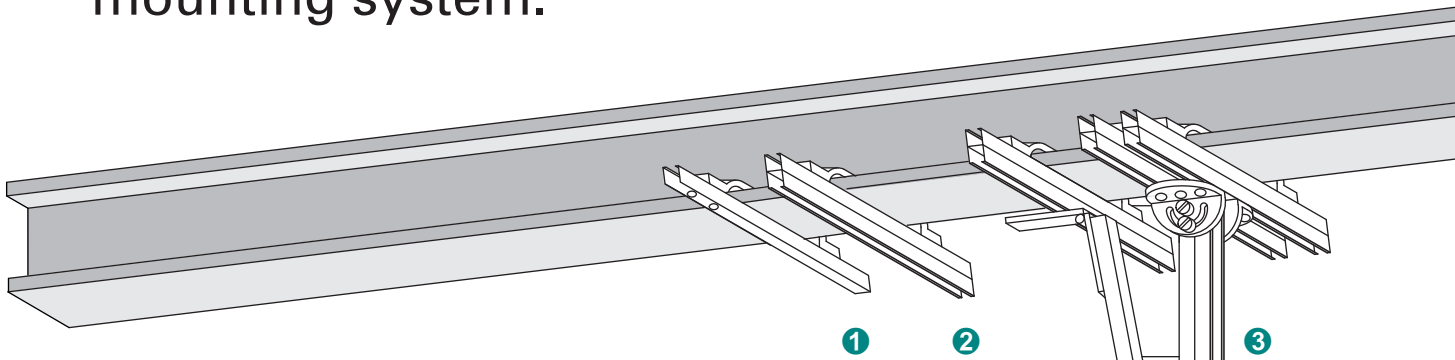

The Deyle trolley bus bar is not only fully engineered, but it is also practical. It starts with the installation as the system comes ready to be mounted to pillars, walls or the ceiling. All required mounting and assembling parts are included in the delivery. Our service technicians will be happy to work out a detailed suggestion for your spatial conditions. After installing the bus bar system, all you need to do is slide in the pre-assembled trolleys.

1 Traverse with clamping claws

MSTR411 0.5 m

MSTR412 0.75 m

2 Twin traverse with clamping claws

MSTR413 0.5 m

MSTR414 0.75 m

3 Suspension rails

MSAH407 0.5 m

MSAH408 1.0 m

MSAH409 1.5 m

MSAH410 2.0 m

MSAH411 3.0 m

MSAH412 4.0 m

4 Angled hinge

MSMT205

5 45° strut

MSMT203

6 Attachment lug on suspension rail with ring nut

MSMS519

7 Suspension bracket

BZAH130

8 Mounting plate

MSAS310

9 Threaded bar

MSMS504

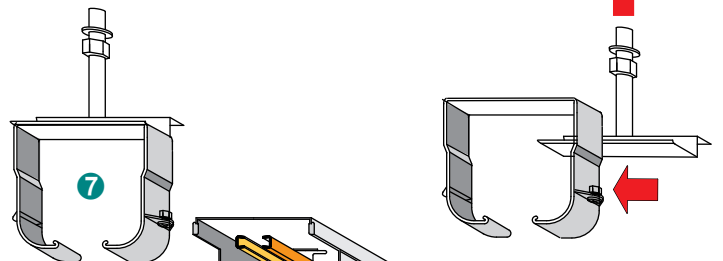

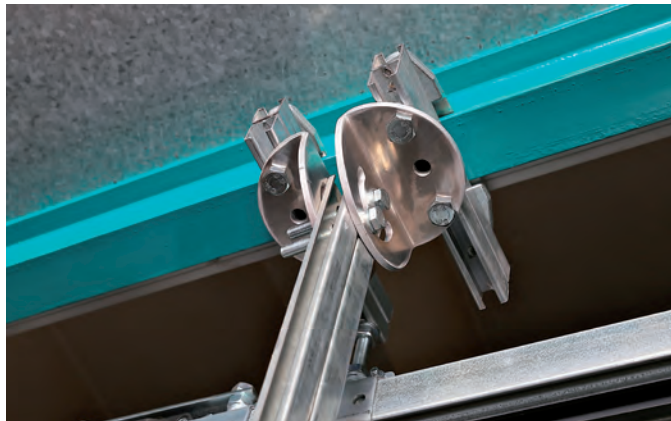
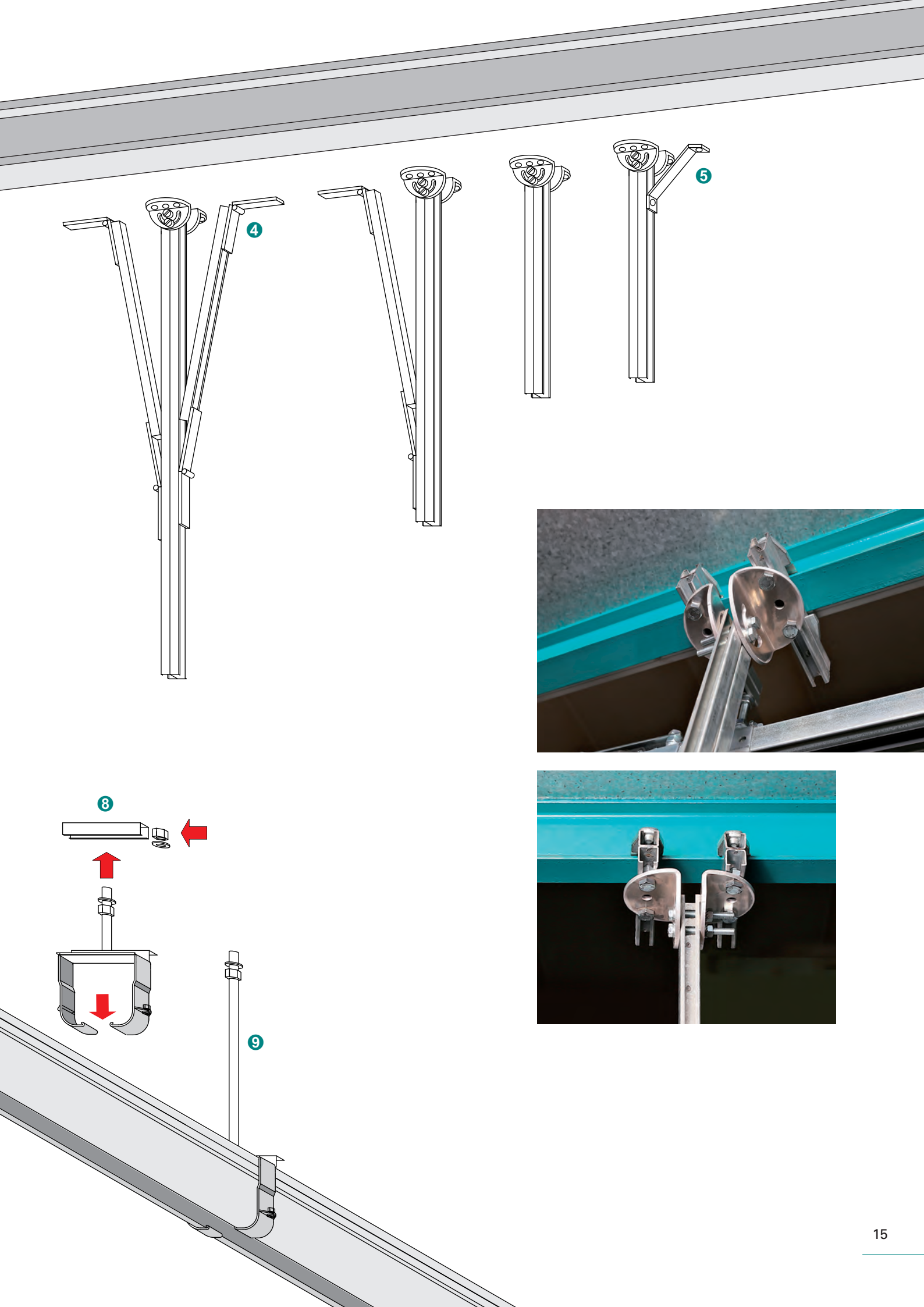

The Deyle trolley bus bar system: Interface between power grid and consumers

The Deyle E-Box designed for use in industry is both rugged and practical. All supporting components are made of metal making them virtually indestructible. We deliver the system pre-assembled and complete with trolleys, cable release, wiring and connections. Simply slide the trolley into the bar, that's it.

Power can be supplied at the head of the bar or at any other point along the system.

1 Bar feeder max. 35 mm²

BAA3-100
BAA5-100
BAA7-100
BAA9-100
BAA11-100

2 Bar feeder max. 16 mm²

BAA3-50
BAA5-50
BAA7-50
BAA9-50
BAA11-50

3 Head feeder 10 mm²

BZEV-110

4 Air hose

5 Slide-on unit

To slide in the trolley via the open end – touch protection through inside insulating stretch

BAI3-50
BAI3-100
BAI5-50
BAI5-100
BAI7-50
BAI7-100

6 Slide-in guide

In addition to BAI5-50 for an automatic feeding into the bar
BAI-T

7 Slide-in piece

To enter a trolley along the course of a bus bar

8 Gate

OZVB-B

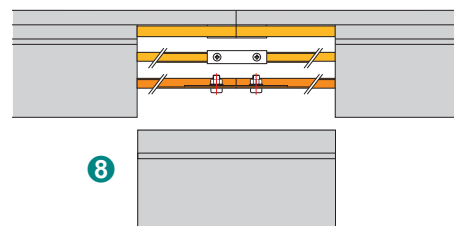
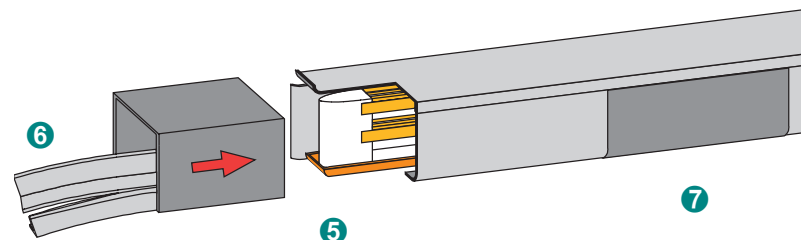
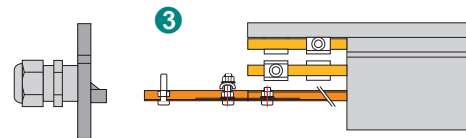
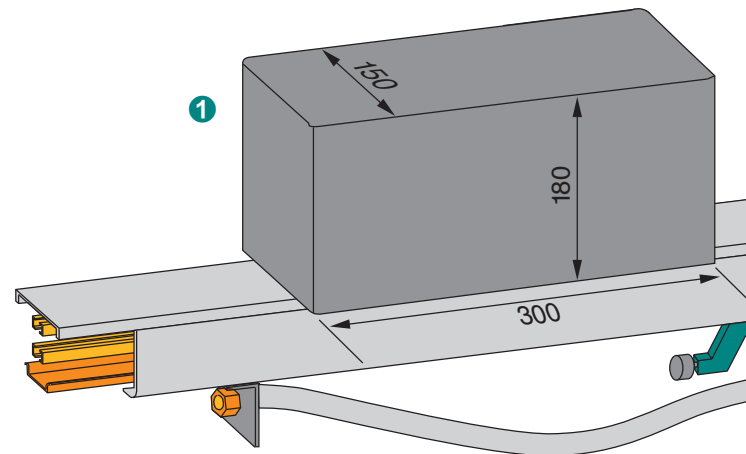

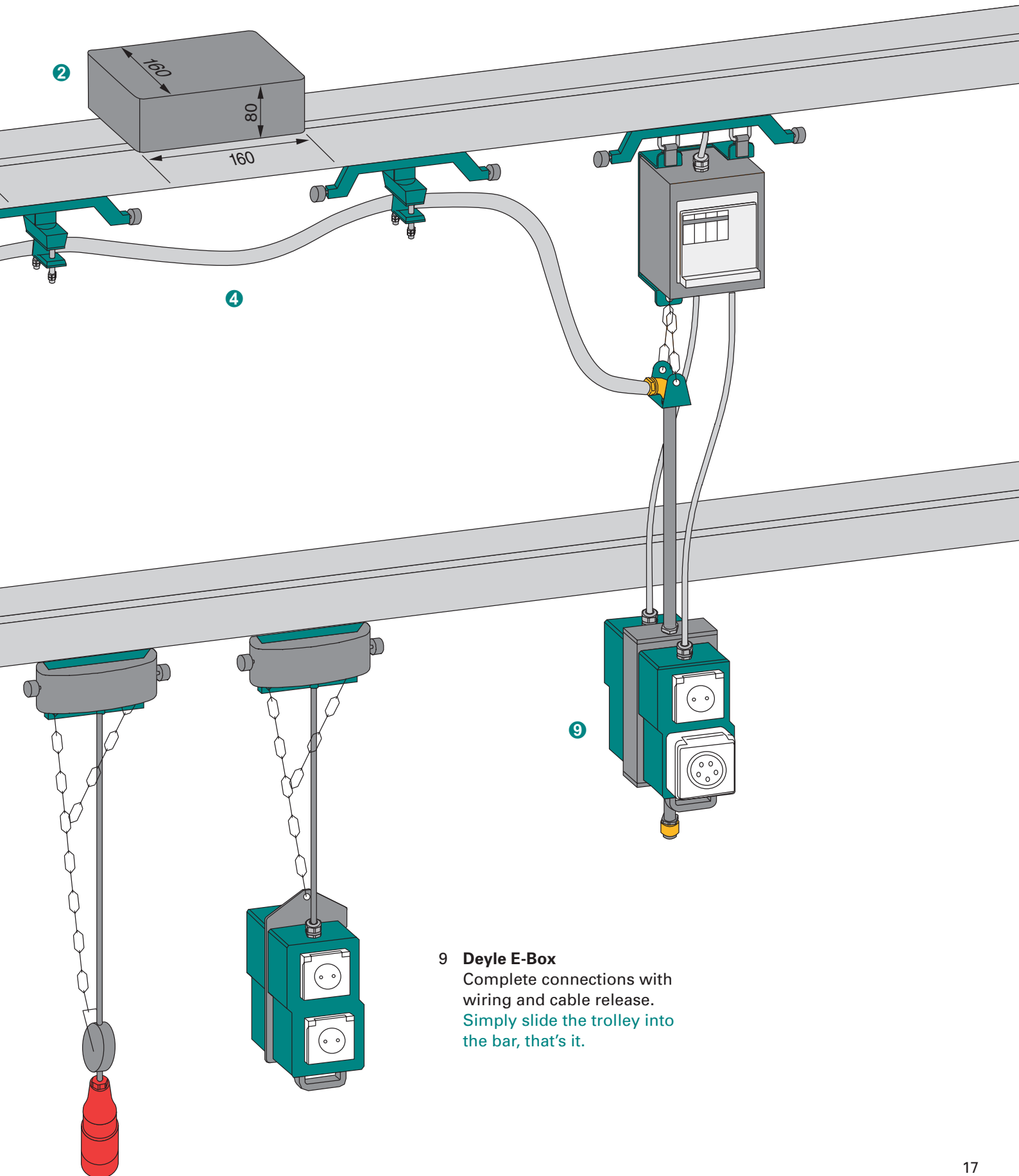

9 Deyle E-Box
Complete connections with wiring and cable release.
Simply slide the trolley into the bar, that's it.

Examples of installations from all industries.

Deyle trolley bus bars convince at most different places of use, like in the automotive or textile industry, in workshops as well as in schools or laboratories.

Just everywhere where safety and efficiency are called for.

A small list of our reference projects:

- **Bosch**, electric tools, Leinfelden
- **Brunnhuber**, cranes, Augsburg
- **German Federal Armed Forces**, Penzing
- **Continental**, tyres, Hannover
- **Dungs**, gas safety engineering, Urbach
- **ebm**, electric motor manufacturing, Mulfingen
- **EnBW**, power utility, Stuttgart
- **EON**, hydropower plant, Landshut
- **FESTO**, automation engineering, Esslingen
- **Franciscan Sisters** of Schönbrunn, convent
- **Fraunhofer Institute**, Freiburg
- **Vocational College**, Donaueschingen
- **HARIBO**, sweets, Bonn
- **University of Hamm-Lippstadt**, Hamm
- **HILTI**, fastening engineering, Kaufering
- **Hornbach**, DIY store, Driebergen (Netherlands)
- **HYMER**, caravans, Waldsee
- **Indupress**, presses for textile industry, Hösbach
- **Intertex-Maschinenbau GmbH & Co KG**, dynamic storage systems, Eislingen
- **JVA** penal institution, Landsberg
- **MEWA-Textilien AG**, textile services, work clothes, industrial textiles, Immenhausen
- **Miele**, electric domestic appliances, Gütersloh
- **NDR**, television, Hamburg

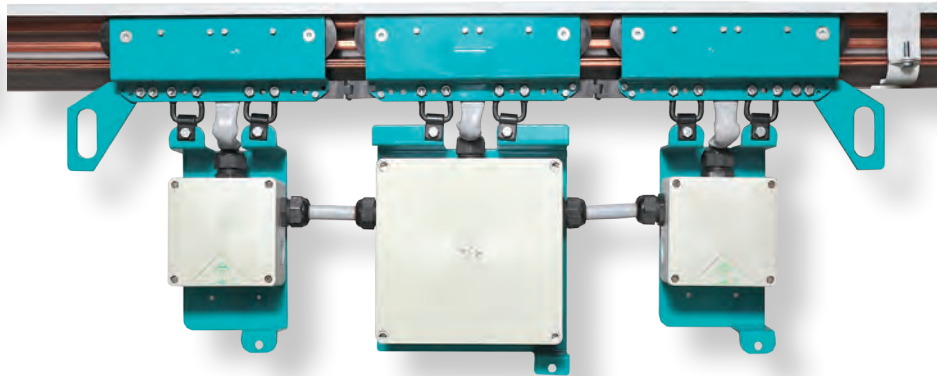

- **Porsche**, automotive, Stuttgart-Zuffenhausen
- **Siemens**, switchgear cabinet manufacturing, Erlangen
- **Thyssen-Krupp Steel Europe AG**, surface engineering, Dortmund
- **Trigema**, sports and leisure wear, Burladingen
- **Triumph**, lingerie, textiles, Heubach
- **Trumpf**, punching machines, Hettingen
- **Waldner GmbH & Co KG**, laboratory equipment, Wangen
- **ZF-Friedrichshafen AG**, transmissions, Lemförde

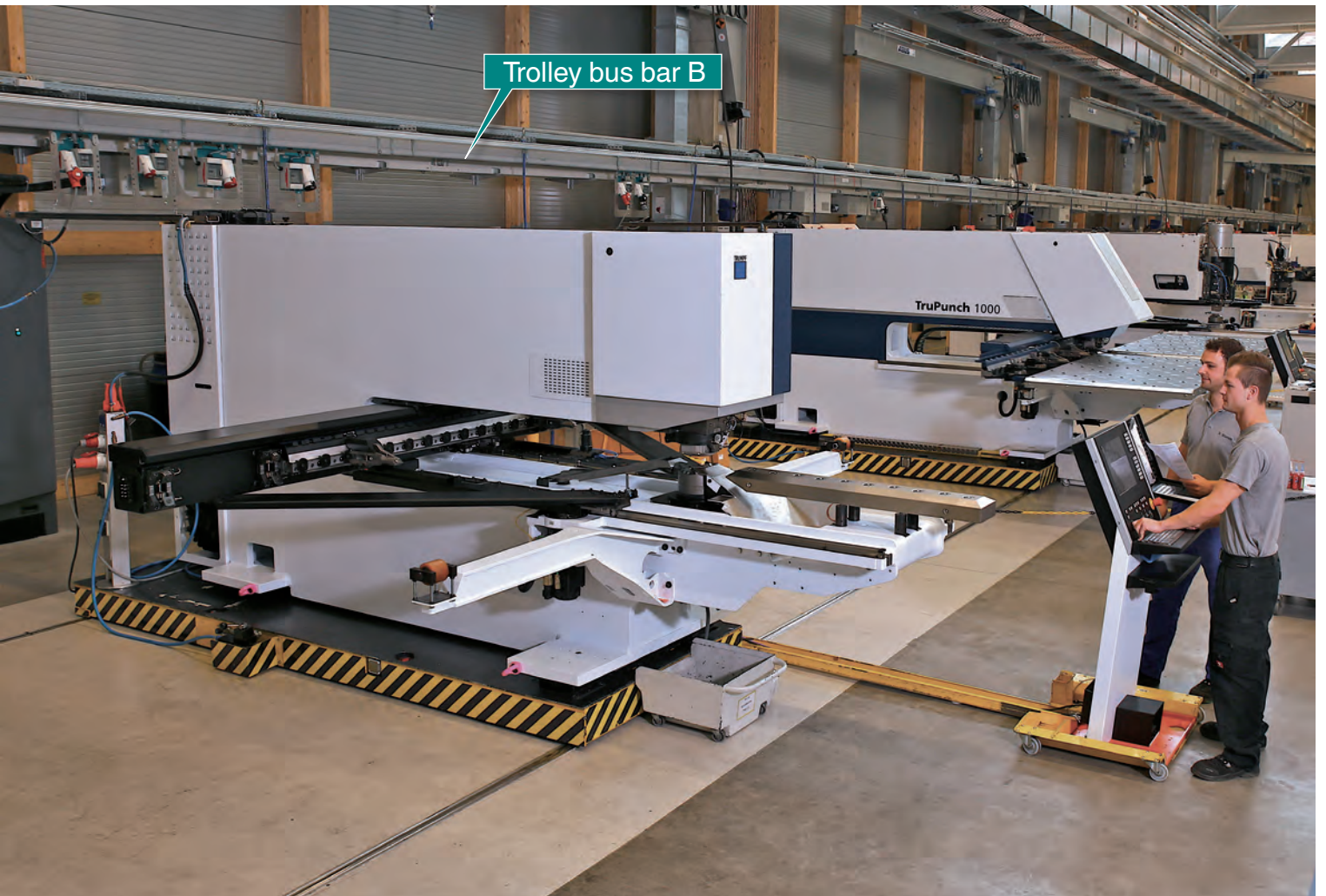

Trolley bus bar B



Trolley bus bar B



Deyle – power all down the line.

For 60 years, the original Deyle bus bars have ensured reliable energy transmission to consumers. Our first installations are still in use, proving the outstanding quality and sustainability of our systems. We have manufactured contact lines, rail and socket distribution units, cable feeder rails and safety bars since 1954.

In 1993, we added a totally new product range with frame heaters for opticians and hearing aid audiologists, which have set a European-wide standard for the whole industry today.

Deyle Power belongs to the Mehl Group, which also owns the Leich + Mehl brand, a leading manufacturer of weighing and labelling equipment. The Mehl Group is a family-run enterprise in the second and third generation.

Deyle Power is innovative, absolutely reliable and offers premium quality. Our competent and friendly customer service will be happy to help you any time, also after having delivered your bus bar system.



This in mind, you should contact us when you plan to have **power all down the line**. We will be happy to support you with our know-how earned in 60 years. Contact us and benefit from our rich pool of tips and tricks. We assist engineering offices in creating requests for tender.

The DEYLE products:

Trolley bus bar Type B

The rugged industrial trolley bus bar.

Trolley bus bar Type D

The compact trolley bus bar.

Festoon cable system F

The cost-effective cable system.

Plug line S

Power wherever you want.

The Deyle switch bar

Safe switching.

Passat frame heaters

For opticians and hearing aid audiologists.



The winning company!

DEYLE

power all down the line

Deyle GmbH

Tulpenstraße 50
71394 Kernen i.R. (near Stuttgart)
Phone +49 (0)7151 4 10 46
Fax +49 (0)7151 4 68 06
mail@deyle-power.de
www.deyle-power.de